

OWNER'S MANUAL



Tigor.ev

OWNER'S MANUAL



TATA MOTORS

Revision: Rev03/ FEB 23

CUSTOMER ASSISTANCE

In our constant endeavour to provide assistance and complete service backup, TATA MOTORS has established an all India customer assistance centre.

In case you have a query regarding any aspect of your vehicle, our Customer Assistance Centre will be glad to assist you on our Toll Free no. **1800 209 8282**
You can also approach nearest TATA MOTORS dealer.

For updated information related to Dealer Network refer link <https://tigorev.tatamotors.com/find-dealer/>
TATA MOTORS 24X7 Roadside Assistance Program offers technical help in the event of a breakdown. Call the toll-free Road-side Assistance.

For additional information, refer to "24X7 Roadside Assistance" section in the Owner's manual



Dear Customer,

Welcome to the TATA MOTORS family,

Thank you on the purchase of TATA MOTORS vehicle.

As a global Indian automobile manufacturer, we focus on innovation, technology and build high quality products with exceeding values of “Connecting Aspirations”.

The Owner’s Manual will familiarize you with the operations, equipment description, features that are either as standard or optional on your vehicle. It is requested you read this manual carefully and follow the instructions and recommendations as mentioned.

You are advised to carry out service, maintenance and repairs at TATA MOTORS Dealers and Authorized service centers throughout the life of your vehicle. Always use genuine parts for continued performance of your vehicle. Avoid modification, non-genuine accessories fitment on your vehicle. TATA MOTORS does not carry any liability arising due to it. Always keep this manual in the vehicle.

You can contact our dealer or Customer Assistance toll free no.(1800 209 8282) in case of any query or support required.

Information provided in this Owner’s Manual is explicit at the time of publication. However, as TATA MOTORS continues to make changes and improve products, it reserves the right to make changes in this manual or any product at any time, without notice and without any obligations.

We look forward for your continued association with us for many years to come.

Wishing you a Safe and pleasant driving experience.

TATA PASSENGER ELECTRIC MOBILITY LTD.

Floor 3, 4, Plot-18, Nanavati Mahalaya, Mudhana Shetty Marg, BSE, Fort, Mumbai, (MH) - 400 001, India

01. INTRODUCTION TO EV

Introduction	1
--------------	---

02. BATTERY INFORMATION

High Voltage Battery System	5
-----------------------------	---

03. CHARGING

Safety Information	11
--------------------	----

Charging Do's And Don'ts	13
--------------------------	----

Types Of Charging	15
-------------------	----

Home Charging Box For Slow Charging Of Your EV	19
--	----

Slow Charging Procedure	20
-------------------------	----

Fast Charging Procedure	29
-------------------------	----

State of Charge (SoC) Gauge For High Voltage Battery	31
--	----

04. SAFETY

Important Information	33
-----------------------	----

Seat Belts	35
------------	----

Child Restraint System (CRS)	39
------------------------------	----

Supplementary Restraint System (SRS) (Airbags)	44
--	----

Child Lock (if equipped)	50
--------------------------	----

Anti-theft Device-immobilizer / PEPS (if equipped)	51
--	----

Anti-lock Braking System (ABS)	52
--------------------------------	----

Electronic Brake Force Distribution (EBD) (if equipped)	53
---	----

05. OPENING AND CLOSING

Keys	55
------	----

Flip Key	57
----------	----

Smart Key (if equipped)	58
-------------------------	----

Smart Key Features	59
--------------------	----

Doors	63
-------	----

Windows	64
---------	----

Bonnet	66
--------	----

Tailgate Opening	67
------------------	----

Opening Charging Port Flap	69
----------------------------	----

CONTENTS

06. DASHBOARD AND FEATURES	
Cockpit	71
Instrument Cluster	72
Warning Lamps	88
Audio Reminders (if equipped)	95
Combi Switch (RH Stalk)	97
Combi Switch (LH Stalk)	98
Dashboard Controls	100
Steering Mounted Controls (LHS) (if equipped)	102
Steering Mounted Controls (RHS) (if equipped))	103
Mic (if equipped)	105
Infotainment System Display (if equipped))	105
USB Port (if equipped)	106
Power Socket	107
Antenna	107
Roof Grab Handle	108
Tag Holder	108
Roof Lamp	109
High Mounted Stop Lamp	109
Head Lamp	110
Tail Lamp	110
Connected Vehicle Program (CVP)	110
iIndirect Tire Pressure Monitoring System (if equipped)	111
07. STOWAGE AREAS	
Storage Compartment	113
Card Holder (if equipped)	117
Hooks (if equipped)	118
08. CLIMATE CONTROL	
Air Distribution	119
Air Vents	120
Fully Automatic Temperature Control (FATC)	121
09. STARTING AND DRIVING	
Pre Driving Checks	129
Tips To Get Maximum Range While Driving	130
Limp Home Condition of EV	132
Before You Start EV	135

Cold Weather Driving	139
Driving Tips	140
Important Tips	141
Seat Adjustments	142
Rear View Mirrors	144
ORVM Folding (if equipped)	145
Sun Visors	146
Steering Wheel Adjustment	147
Steering Lock Cum Ignition Switch	148
Electrical Power Assisted Steering (EPAS)	149
Gear Modes	150
Starting And Driving (PEPS)	150
Reverse Park Assist With Sensor (if equipped)	154
Rear View Camera	157

10. EMERGENCY AND BREAKDOWN ASSISTANCE

Emergency Equipment	165
Spare Wheel Removal Process	167
In Case Of Flat Tyre	168
Tire Puncture Repair Kit (if equipped))	171

Towing	176
Fuses	178
24 X 7 Road Assistance	191

11. MAINTENANCE AND SERVICES

Maintenance and Services	197
Do It Your Self	198
Motor Compartment	199
Tyres	202
Smart Key Battery Replacement (For PEPS Variant)	205
Remote Key Battery Replacement	206
Service Instructions	207
Service Schedule	208
Vehicle Parking For Long Duration	214

12. TECHNICAL INFORMATION

Lubrication Specification	215
Technical Specifications	216
Vehicle Dimensions	219

CONTENTS

Aggregate Identification Numbers	220
13. CAR CARE	
Car Care	221
Fastag	223
Warranty – Terms And Conditions	224
Extended Warranty	226
Value Added Services	228
Vehicle Exterior Enrichment	230
Vehicle Interior Enrichment	231
14. ENVIRONMENT SAFETY	
Environmental Safety	233

INTRODUCTION

An electric vehicle is powered by a battery - Edrive and it does not need any type of fossil fuel. While conventional vehicles use an internal combustion engine and gasoline or diesel as fuel, electric vehicles use electrical energy that is stored inside the high voltage battery. As a result, electric vehicles run on electricity, they are eco-friendly, they do not require fuel and are zero emission vehicles.

The Tigor.ev is an electric vehicle, some of the vehicle's systems operate differently and have different operating characteristics than vehicles equipped with an internal combustion engine. It is important to carefully read the entire Owner's Manual for this reason.

Tigor.ev uses two types of battery systems a high voltage system in which a high voltage battery powers the inverter and electric motor which in turn propel the vehicle and a low voltage system in which a 12-volt battery provides power to the vehicle systems and features such as the audio system, supplemental restraint systems,

headlights and windshield wipers. The high voltage battery also charges the 12-volt battery.

The high voltage battery must be charged with electricity before the vehicle can be driven. As the vehicle operates, the battery gradually discharges and when completely discharged, the vehicle needs to be plugged in for charging. To increase the range of the vehicle in a single charge, re-generative braking has been incorporated. Basically, while the vehicle is coasting or braking, the motor works as a generator and converts the vehicle motion (kinetic energy) to electrical energy to charge the HV battery.

The electric motor is mated to a reduction gearbox which comprises the vehicle drivetrain. This electric-only powertrain significantly reduces motor room noise and vibration while driving.

Important Information

The images / illustrations in this Owner's manual are only for reference. It may differ with actual vehicle. In this Owner's Manual, you will find the text under the heading "WARNING" and "NOTE" which

highlights important information. Pay particular attention to these highlighted messages.

NOTE

Indicates additional information that will assist you in gaining the optimum benefit and care for your vehicle.

WARNING

Indicates procedures or information that must be followed precisely in order to avoid the possibility of severe personal injury and serious damage to the vehicle.

CAUTION

It indicates to be careful. You are capable of doing something that might result in damage to equipment.

Main Components

On-board Charger (OBC)

A device that charges the high voltage battery by converting AC power from a domestic supply into DC power and supplying it to the battery.

INTRODUCTION TO EV

Inverter

A device that transforms direct current (DC) from the high voltage battery into alternating current (AC) to power the electric motor. It also converts braking energy into electrical energy and charges the high voltage battery while decelerating or braking.

DC- DC Converter

A device that converts HV DC power from the HV battery to LV DC power which is required to maintain LV battery charge, which in turn powers the LV systems like lights, wipers, infotainment, etc. in the vehicle.

Electric Motor

A device that converts electrical energy into rotational mechanical energy which is then transferred as rotational torque to the wheels through the gearbox in order to drive the vehicle.

High Voltage Battery (lithium ion)

An on board high voltage electrical energy storage device.

Power Distribution Unit

Distributes power from the high voltage battery to the HV components like inverter, DC-DC converter, E-compressor etc.

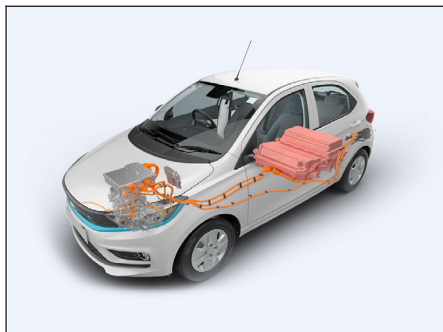

General Warnings

- Your vehicle contains a sealed Li-ion high voltage battery. If the High voltage battery is disposed of improperly, there is a risk of severe burns and electrical shock that may cause serious or fatal injury/casualty and there is also a risk of environmental damage.
- The EV system uses high voltage DC current. The system can be hot during and after starting and when the vehicle is shut off. Be careful of both the high voltage and the high temperature.
- Avoid exposure to high voltage components. Observe all warning labels mentioned on components or areas. Observe all orange cables large and small which carry high voltage.
- Do not touch high voltage components while the vehicle is in operation or ignition on.
- Do not disassemble, remove or replace high voltage parts and cables as well as their connectors because they can cause severe burns or electric shock or may cause serious or fatal in-

jury/casualty.

- The vehicle high voltage system has no user serviceable parts. It is recommended that you take your vehicle to a TATA MOTORS EV service center for any necessary maintenance.
- Pay special attention to pedestrians. Because there is no motor noise, pedestrians may not know the vehicle is approaching, moving or about to move, and may step into the path of vehicle travel.
- When leaving the vehicle, be sure to turn off the EV system. The EV system uses high voltage current. Ensure Parking Brake to be engaged. Failure to follow the proper handling instructions may cause serious or fatal injury/casualty.

Safety of the High-voltage System

- Do not perform any modifications or work on the vehicle, especially maintenance and repair work on the high voltage system and the body and avoid retrofitting accessories.
- If work is not carried out properly, there is risk of fire and fatal injury from electrocution due to the high-voltage system.
- TATA MOTORS recommends to have modifications and work on the vehicle only to be carried out by TATA MOTORS Authorized EV Service Centre or one that operates according to TATA MOTORS' specifications with personnel trained accordingly.
- Your vehicle's high-voltage system is a self-contained system. Safety is ensured as long as no work is performed on electrical components or on the chassis.

High-voltage System: Contact with Water

The high-voltage system is typically safe even in the following example situations:

- Vehicle is in water but only up to 300 mm.
- Liquid escapes in the trunk.

In these cases there is no risk of injury from electrocution. Other damage to the vehicle is possible.

INTRODUCTION TO EV

Common Terminologies used in this Manual and their Abbreviations

EV – Electric Vehicle

HV battery – High Voltage battery

LV battery – Low voltage or 12V battery

AC – Alternating Current

DC – Direct Current

OBC – On Board Charger

PDU – Power Distribution Unit

VCU – Vehicle Control Unit

OBD -On Board Diagnostics

SoC – State of Charge

SRS – Supplementary Restraint System

CRS - Child Restraint System

DAB – Drive Airbag

PAB – Passenger Airbag

ABS – Anti Lock Braking System

EBD – Electronic Brake Force Distribution

PEPS- Passive Entry/Passive Start

ESCL – Electronic Steering Column Lock

EPAS – Electric Power Assisted Steering

LED – Light Emitting Diode

DRL – Daytime Running Lamp

ORVM- Outer Rear View Mirror

IRVM – Inside Rear View Mirror

HVAC – Heating Ventilation and Air Conditioning

FATC – Fully Automatic Temperature Control

DIS – Driver Information System

DTE – Distance to Empty

IGN – Ignition

RCBO – Residual Current Breaker with Over-Current

BMS – Battery Management System

in the following sections.

HIGH VOLTAGE BATTERY SYSTEM

The Tigor.ev is powered by a lithium ion battery pack and it is managed by a highly intelligent battery management system that controls the output and behavior of the high voltage battery pack. This BMS is powered up by the low voltage battery present in the vehicle.

It is essential to ensure the presence of ample voltage in the low voltage battery to enable the function of the lithium ion battery. Please refer to the LV battery maintenance section to maintain your battery at optimal working conditions.

It is essential to note that even when it is not in use, the HV battery undergoes discharge (Approx. 2% State of Charge in 30 days) over a stagnant period.

Please refer to the 'Charging' section on how vehicle charging is performed correctly.

The HV battery must never be allowed to discharge completely, as this situation causes a damage to the life of the battery and must be charged regularly.

In a situation where the vehicle has undergone complete discharge, please contact the TATA MOTORS Authorized EV Service Centre for further assistance.

It is recommended to charge up to 100 % during every charging for best performance of battery pack.

If warning related to battery appears, communicate to TATA MOTORS Authorized EV Service Centre.

The Tigor.ev is powered by 24 kWh or 19.2 kWh high voltage lithium ion battery pack, which in turn powers the electric motor to drive the front wheels. This high voltage battery also powers the air-conditioner and an auxiliary battery (12 V) that drives the lamps, wipers, and audio system. The auxiliary battery is automatically charged when the vehicle is in the ready mode or the high voltage battery is being charged.

Before you drive the car, it is essential that you read the owner's manual to understand the basics of battery and charging of your EV to prolong the life of battery pack. Be sure to read the warnings and cautions

WARNING

The battery and motor are not user serviceable. Do not inspect, remove or disassemble any of the high voltage electrical components in your vehicle as it could may cause serious or fatal injury /casualty.

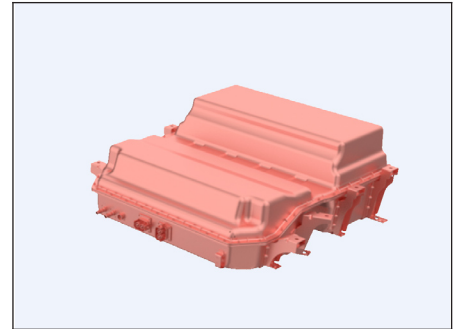

BATTERY INFORMATION

Since the battery pack is not user serviceable, we urge you to visit the nearest TATA MOTORS authorized EV service centre to safely recycle or dispose the battery. Do not attempt to recycle or dispose the battery yourself, as it might result in severe injury or even death. There is also a risk of environmental damage.

CAUTION

Keep the following things in mind to prevent damage of the battery pack:

- Avoid exposure of the vehicle to extreme environmental temperature for extended period of time.
- Do not leave the vehicle for longer period when High voltage battery is near zero SOC. Follow the long duration storage guideline.
- Do not use the High voltage battery for any other purpose.
- The capacity of the High voltage battery will decrease with time and usage to hold charge like all such batteries. As the battery ages and

capacity decreases, this will result in a decrease from the vehicle's initial mileage range. This is normal, expected, and not indicative of any defect in your High voltage battery.

- When the HV Battery reaches the end of its life cycle, the charging capacity or State of health (SoH) reduces. During such decrease in charge capacity and range of vehicle, contact an authorized service centre and get the SoH of Battery pack get inspected.
- It is recommended that the vehicle must be charged greater than 50% before leaving the vehicle for long resting period (>15 days). After the resting period the vehicle must be charged to 100% using slow Charging before use.
- One full slow charging after every 4 fast charging cycle is recommended for regular charging.
- If over time the maximum charge capacity and the maximum electric

range begin to degrade, contact an authorized TATA MOTORS EV dealer for inspection and maintenance.

- If the vehicle is involved in a collision, we recommend that you contact an authorized TATA MOTORS EV dealer to inspect if the high voltage battery is still connected or damaged in any way.
- The HV battery capacity of the high voltage battery may decrease when the vehicle is stored in high/low temperatures.
- Electric range may vary depending on the driving conditions, even if the charge amount is the same. The high voltage battery may expend more energy when driving at high speed or uphill. These actions may reduce the vehicle electric range.

- Natural degradation may occur with the high voltage battery depending on the number of years the vehicle is used. This may reduce the vehicle range.
- Be sure to read the warnings and cautions in the following sections.

Temperature Limits

Battery pack is maintained to operate between 20°C to 35°C to ensure best performance.

Battery pack can operate safely in limits of 0 to 55°C.

NOTE

To control the battery temperature of the high voltage battery the air conditioner is used to cool down the battery and may switch on automatically without request from control panel which may generate noise from operation of the air conditioner compressor and cooling fan.

Battery Life

The Tigor.ev comes with a battery life of 8 years or 1,60,000 km warranty for the battery, whichever is earlier. Regular service of the vehicle and recommended charging protocol to be followed to maximize the battery life.

Energy Information

Tigor.ev battery pack has a maximum energy of 24 kWh or 19.2 kWh. Energy retention capacity deteriorates over several cycles of usage and hence range deterioration happens overtime.

This decrease in range during the end of life of battery is expected and is not considered as a malfunction of the battery pack. During these conditions, it is recommended to contact an authorized service centre for inspection.

Energy Recovery System

The Tigor.ev features energy regeneration system, which regenerates expended energy during coasting or braking during the drive. This system allows the battery to be recharged under the above men-

tioned conditions.

Please note, the regeneration system does not fully recharge the battery, it only provides a chance to recover a portion of energy that would be lost during braking.

Heavily Discharged High Voltage System

In the case of a heavily discharged HV battery, there is a chance that the low voltage battery is discharged as well. In this case, please contact your nearest TATA MOTORS EV Service Centre for further assistance. Do not try to jump start the vehicle or tow the vehicle without guidance from the service assistant.

Heated High Voltage Battery

In such a condition, the battery has safety logics to limit the performance or disconnect by itself with prior warning. The vehicle should be stopped and allowed to cool down and TATA MOTORS EV Service Centre must be contacted for rectification.

Predicting Energy Usage

The Tigor.ev battery energy usage is displayed in the instrument cluster in the form

BATTERY INFORMATION

of estimated range. This range is updated by the system algorithm, depending on the driving conditions.

Displayed range in the instrument cluster is a tentative number based on drive route, driving pattern and usage pattern history over the past drives.

High Voltage System Failure

In the case of high voltage system failure, which may arise due to various reasons, contact TATA MOTORS EV service centre for further assistance.

Disposal

The disposal of an HV Battery will be carried out by TATA MOTORS EV dealer or authorized agency at the end of the battery life time or if the battery pack has passed its warranty period.

Tips to Conserve Battery Life

1. Battery Charging

It is advisable to charge the vehicle upto 100%. This ensures accurate SoC calculation and consistent energy content intake during charging. Charging to 100% also maintains battery health for longer time and ensures better range throughout the life cycle of the vehicle.

It is also advisable to slow or home charge the vehicle to 100% as much as possible. Slow Charging and full charging is the best way to charge your vehicle to maintain the health of the high voltage battery.

If fast charging is used, it is advisable to slow or home charge the vehicle from less than 20% charge to 100% for every 4 fast charging cycles.

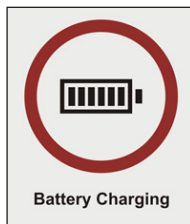

2. Cell Balancing or equalization

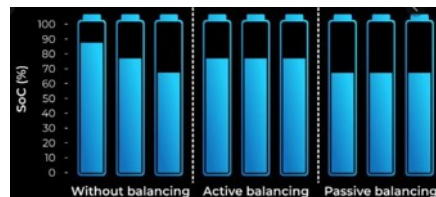

Cell balancing or equalization and SoC calibration happens during charging, especially at higher SoC, > 90%. This causes charging to take longer time above 90%. Allow the vehicle to reach 100% SoC before terminating the charging session, as both cell balancing and SoC calibration are essential steps for any battery to perform optimally for a prolonged time

3. Extreme Temperatures

Extreme temperatures impact upon how well a battery can maintain its level of charge. Avoid charging the high voltage battery when it is hot and vehicle is



driven for long distances especially in summers. Allow vehicle temperature to cool down before charging. It is always better to charge EV when ambient temperature is low especially at night.

4. Vehicle Parking

Avoid parking vehicle in direct sunlight for long duration. Try to park it under shade, tree etc. This helps in keeping battery temperature low resulting enhance battery life over the life cycle.



SAFETY INFORMATION

Carefully read these instructions and the charging instructions before charging your electric vehicle. The Slow Charging gun is located inside the boot of the vehicle.

As shown in the image, the parts for Slow Charging system are:

1. Home Charging box socket
2. Plug
3. Control box
4. Charging gun
5. Charging Port

Charging Box Socket

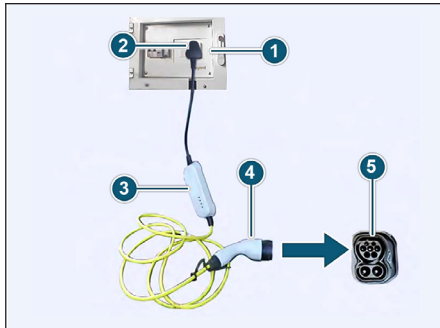

CHARGING

Safety Guidelines for Preventing Fire and Electric Shock

- Make sure the charge station's supply cable is positioned such that it will not be stepped on, tripped over, or otherwise subjected to damage or stress.
- There are no user serviceable parts inside the charging gun. Contact authorized TATA MOTORS EV Service Centre should you experience any problems with the charging gun. Do not attempt to repair or service the charge station or charging gun yourself, which may result in injury.
- Do not operate your charge station and gun if it or the supply cable is visibly damaged. Contact your Service Representative for service immediately. Refer to the 'Emergency and Break-down' section in this manual for information on the Service Representative in your area.
- Do not place fingers inside the coupler on either end of the charging gun.
- Do not allow children to operate this device. Adult supervision is mandatory

when children are in proximity to a charge station that is in use.

- Not for use in commercial garages.

WARNING

Unplug both couplers of your Portable Charging Gun before cleaning.

NOTE

During normal operation, the charging gun or couplers may feel warm. If either hot coupler or the charging gun feels hot during charging, unplug the gun and have a qualified electrician inspect the connections before you continue charging.

CAUTION

Do not use a damaged charging station, domestic plug point or charging port. Both charging gun couplers must fit tightly into receptacles that are in good condition. Using the charger with a worn or damaged port may cause burns or

start a fire.

WARNING

The charger generates electromagnetic waves that can seriously impact medical electric devices such as an implantable cardiac pacemaker in a person. When a person has an implant like the one mentioned above, make sure to ask the medical team and the manufacturer whether charging your EV will impact the operation of the medical electric device implant. In such case, do not go near the vehicle when it is charging.

WARNING

Ensure that the charging gun is always stored in a safe place. Do not expose it to rain or wet conditions. Avoid pouring or dripping water or other liquids over it. If water penetrates the electrical devices, the risk of electric shock increases. Ensure that all plugs and

cables are free of moisture before using the charging gun. Never connect the charging gun to the mains with wet or moist hands or when the charging gun is wet.

NOTE

Charging station and domestic plug point must be approved/certified by a qualified electrician before using the charging gun. Coupler Receptacle has to have proper Grounding, electrical connection and has to contain a Residual-Current Circuit Device (RCD).

CAUTION

Make sure that the device is always stored in a safe place. Do not expose the device to rain or wet conditions. DO NOT use this product if the EV charge connector/cable is damaged. During charging the vehicle must not be exposed to rain, lightning and snow.

NOTE

Charging should be done in Ignition OFF state.

CHARGING DO'S AND DON'TS

- The charging gun provided for home charging has to be stored safely and securely in the trunk of the vehicle or has to be plugged on to the Home Charging Box in locked condition.
- The wall box charging unit is also used for slow or home charging. It comes with a key and lock. It is recommended to lock the home charging box when the vehicle is kept for overnight charging or when nobody is around while the vehicle is being slow charged. This ensures that the charging unit along with the charging gun cannot be misused or stolen.
- Wet surfaces are good conductors of electricity. Though the vehicle is equipped with safety mechanisms to protect users, it is advisable to take a few precaution while plugging in for charging. Hence, before charging, ensure that the power source socket, the charging gun and the charging port (CCS2) port in the vehicle are dry. Also ensure that you are standing on dry

CHARGING

- ground and your hands are dry as well while using the high voltage charging equipment.
- Usage of damaged cables, Power Source socket and vehicle side CCS2 port must be avoided as they may result in electrical hazard and inconsistent charging experience.
 - While plugging in for home charging, ensure power source is off. Subsequently ensure charging gun is connected at both ends – One at power source and the other at vehicle's CCS2 port. Then switch ON the power source switch to commence charging. Confirm that the vehicle is charging from the green charging tell tale displayed on the instrument cluster. The cluster remains ON to display charging status for 60 sec after the start of charging.
 - If charging gun is removed before 100% charging and again needs charging upto 100%, it is advisable to wait for at least 10 seconds before reinserting the gun in the charging port.
 - Once charging is complete and gun is removed from the charging port, it is advisable to pause for 30 sec before switching on the car to start driving.
 - When the vehicle is shutoff after drive, it is advisable to pause for at least 10-15 sec before charging. It allows the vehicle's electrical system time to de-energize and stabilize before the charging commences.

TYPES OF CHARGING

There are two types of charging provided in your Tigor.ev – Slow and Fast charging methods. In Slow Charge, plug the charging gun (provided with the car) into a 230V electrical outlet. For Fast Charging, go to the nearest Fast Charging station (CCS Type 2) to charge your car in a short duration.

Slow Charging (AC Charging)



- In electricity grid, electric power is AC (alternating current) by nature. However, electric power in battery is DC (Direct Current) by nature. Hence, to charge an electric car by AC grid, power has to be converted from AC to DC. And to convert AC power to DC power On-board Charger is used. This

type of charging is called Slow charging / AC charging.

- Slow charging is recommended for usual charging of the vehicle. This charging method is most suitable for parking spots where the car will stay parked for longer duration of time.
- Slow charging generally refers to AC home charging or wall box charging. It is advisable to always charge vehicle with slow charging as it helps to enhance battery life, ensure consistent vehicle and battery performance and also maximize driving range.
- It is advisable to charge the vehicle to 100%. This ensures accurate SOC calculation, cell balancing and consistent energy content intake during charging. Charging to 100% also maintains battery health for longer time and ensures better range in the long run. If charging has to be stopped at less than 90%, it is advisable to ensure that vehicle is charged to 100% every 4 charging cycles.
- Alternately, in case where charging

does not happen as frequently, please charge the vehicles to 100% at least once a week.

- Slow charging happens in vehicle off condition or ignition on condition. However, it is recommended to charge the vehicle in off condition in order to ensure optimum energy consumption/ efficiency and charging robustness. It is also recommended not to change power state during charging, unless absolutely necessary as it may cause interruptions/ discontinuation in charging.
- Charging only happens in park brake engaged condition. So always keep the park brake engaged during a charging session.

Fast Charging (DC Charging)

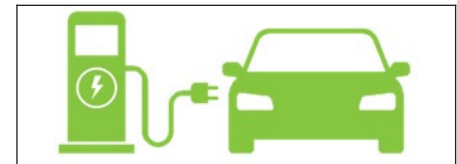

- Fast charging of electric vehicle is

CHARGING

achieved by using Fast/DC charging stations; they convert the AC power from the grid to DC power and can directly charge the HV battery pack thus bypassing the On-Board Charger.

- Fast charging can be done wherever Fast/DC charging station is available. User can charge at high speeds at public charging stations.
- Fast charging refers to DC charging at dedicated stations. Fast charging is a faster method to replenish the High voltage battery.
- Opportunity charging is a charging session in which the battery is not charged to 100% during the charging session. Typically the high voltage battery is charged up to 80-90% SoC.
- This charging scenario is not healthy for a battery as it does not allow for cell balancing and SOC calibration which happens at higher SOC, > 90%.
- Consecutive and multiple use of fast or opportunity charging results in inconsistent battery performance. Hence, it is advisable to use fast or opportunity





charging only when necessary, i.e. when on long trips, away from home charging facilities etc.

- If fast or opportunity charging is used, it is recommended to slow charge the vehicle from <20% charge to 100% after maximum 4 fast or opportunity charging sessions.

NOTE

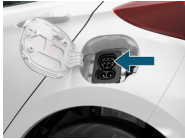
In order to derive optimum performance and durability from the pack, it is recommended to use slow charging frequently and fast charging only when required. It is recommended to perform slow charging at least after every 4 cycles of fast charging.

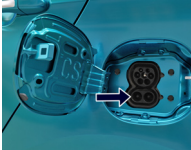
Here are the Details of the Different Types of Charging Mechanisms:

Types Of Charging	Charging Specifications	Charge Port	Charge Gun	Power Source
Slow/AC Charging	<ul style="list-style-type: none"> Nominal voltage: 230 V ac RMS Single phase, 50Hz supply Voltage range <ul style="list-style-type: none"> Minimum voltage = 190V ac RMS Maximum voltage = 250V ac RMS Power rating = 3.3 kW ac RMS Rated current 15A ac RMS 15A plug point 			
Fast/DC Charging	<ul style="list-style-type: none"> Nominal voltage: 320V DC Charging station (CCS Type 2) voltage capability should be greater than or equal 370V DC. 			

CHARGING

Slow / AC Charging

It takes about 9.4** hours at room temperature and normal operating conditions (refer the specs table in previous page) for the EV to charge from 10% to 100% with Slow Charging. The charging gun will be locked after switching on the AC supply.

Fast / DC Charging

Tigor.ev can be fast charged using any fast charging station or equipment compliant to Combined Charging System standard having Type 2 connector (CCS Type 2). It takes 59** minutes for the high voltage battery to charge from 10% to 80% using any CCS Type 2 fast charging station. The charging gun will be locked after switching on the DC supply.

NOTE

Depending on the condition and durability of the high voltage battery, charger specifications, charger rating, and ambient temperature the time required for charging the high voltage battery may vary.

Precaution for Slow Charging

1. Proper maintenance of earthing pit is must. Add water & add salts at regular intervals into the earth pits in order to maintain the value of earth resistance. Check annually the condition of the electrodes so as to add or replace electrodes.
2. The electrical socket used for EV charging and its associated wiring should be able to supply 15A dedicated load continuously.
3. Check the charging inlet for accumulation of dust or any foreign objects.
4. Don't try to pull off the charging gun during charging.
5. Don't pull out the charging gun if it is in locked condition as excess force can break or damage the locking mechanism.

Charging Instruction

1. Vehicle must be parked with park brake in engaged state before connecting the charging gun.
2. Vehicle charging port must be free of

dust, water or snow while connecting the charging gun if not proper cleaning method must be used to remove dust, water and ice. Refer 'Section 6. Cleaning of Vehicle Inlet'.

3. If the charging gun is removed, reinsertion should be done after at least 10 seconds of removal of the charging gun.

Gun Unlocking Feature on EV



Before unlocking the charging gun, switch off the ac power supply and press the "charging gun unlock switch", on dashboard panel.

In case of Fast charging, it will take around 15 to 20 sec for the charging gun to unlock.

NOTE

In emergency charging shutdown conditions, Gun won't be unlocked. Contact authorised TATA EV Service Centre.

i NOTE

In unforeseeable circumstances if the charging gun is stuck to the socket after charging is done, user has to contact the service personnel. No mechanical override to remove the charging gun is available for user.

HOME CHARGING BOX FOR SLOW CHARGING OF YOUR EV



In order to provide customer a seamless charging experience at home, TATA MOTORS provides a complimentary home charging box and its installation at customer premises.

This Home charging box is to be installed in customer's dedicated parking area or

near the EV parking slot.

Customer to use this charging socket for regular slow charging purpose of EV.

This charging box consist of:

- Switch & Socket (25 A) suitable for long hours of usage.
- RCBO - Residual circuit breaker with overcurrent protection to ensure electrical safety.
- Charger Holder/Mounting Bracket for holding the charging cable controller.
- Lockable Metal box assembly for prevention of Electricity theft since this unit is powered by customers own electric meter.

In case of any damage or any malfunction if observed in home charging box, please connect to your TATA MOTORS EV dealership for assistance.

Warranty Period

3 Years Warranty for below components of home charging box

- RCBO, Switch, Socket and enclosure box with locking mechanism.

CHARGING

SLOW CHARGING PROCEDURE

1. Engage the park brake. (**Charging will not start without engaging the park brake**).

NOTE

Ensure vehicle is in OFF / Ign ON condition.

2. Connect the plug to AC power socket.



3. DO NOT plug into a power strip.



4. Open the Protective cap on charging gun.

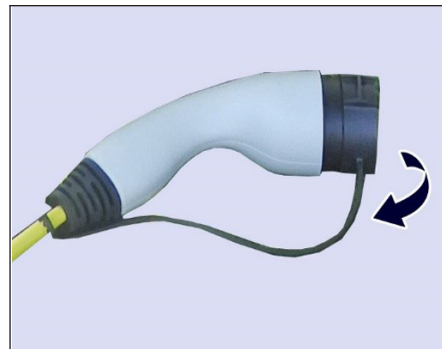

5. Pull the 'Charging-inlet Flap Open Lever' to open the charging inlet flap.



6. Open the protective cap on charging inlet.

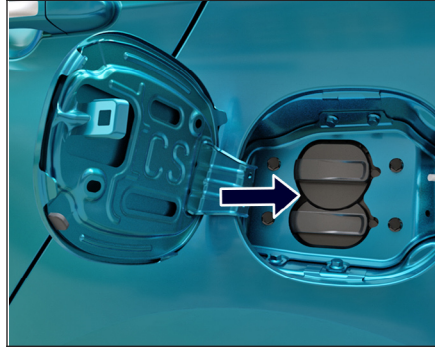

8. If the actuator is engaged and the gun is not getting inserted properly, contact TATA MOTORS EV service center.
9. Remove any dust on the Charging Gun and Charging Inlet. Connect the charging gun to vehicle AC Charging Inlet.

7. Before connecting the charging gun to vehicle charging socket, make sure the gun lock is released.



⚠ CAUTION

If the Gun Lock is not released please don't insert the Charging Gun forcefully into the socket. It may damage the Charging Socket.

CHARGING

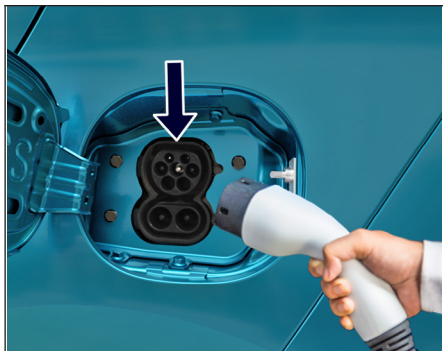

10. Switch on the AC supply.

11. Charging Gun will be locked after switching on the AC supply. You will hear a “click” sound, when the gun is connected correctly.



NOTE

When vehicle is in Charging Mode, it will not go in Drive (D), Sport (S) or Reverse(R).

12. Normally the car starts charging automatically. If not, please refer 'Troubleshooting Guide for Slow Charging' table.

13. Open the door and see instrument cluster for State of Charge, Time to Charge and Gun connection status.

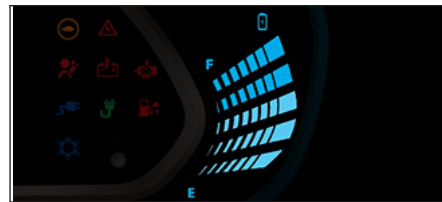

14. In case the park brake is not engaged or partially engaged the charging won't start and 'Engage Park Brake to start charging' message will be displayed on instrument cluster.

15. To stop the charging, switch off the AC power supply.

16. Press the charging gun unlock switch displayed on dashboard panel.

17. Remove the plug.

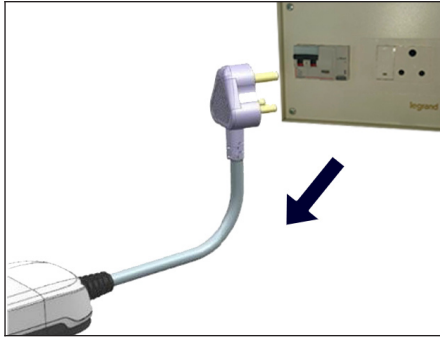

18. Put on the protective caps on both charging gun socket and vehicle inlet socket.

i NOTE

- Once Slow/Fast charging is completed, 90 seconds of time gap is required before the vehicle can be started.
- After turning off the vehicle, wait for four seconds if you want to start the vehicle again.

i NOTE

In emergency charging shutdown conditions, Gun won't be unlocked. Contact authorized TATA Service Centre.

i NOTE

In unforeseeable circumstances if the charging gun is stuck to the socket after charging is done, user has to contact the service personnel. No mechanical override to remove the charging gun is available for user.







CHARGING

Slow Charging Control Box Indications

1. Home
2. Control box
3. Vehicle
4. Fault















Slow charging control box

















Working State	Home	Control Box	Vehicle	Fault	Example	Description
Self-inspection state	Blink	Blink	Blink	Blink		Self-inspection for system
Standby state	On	Off	Off	Off		No fault Check for engagement of park brake
				Blink		Plug temperature is high
Charging state	On	On	Blink	Off		No fault
				Blink		Plug temperature is high
Charging stopped	On	On	On	Off		No fault
				Blink		Plug temperature is high

CHARGING

Troubleshooting Guide for Slow Charging

Refer the below table if charging is not starting or if it stops abruptly. The below symbols of 'House', 'Control Box', 'Vehicle' and 'Fault' can be seen on the control box beside the respective LEDs.

Fault Category	Indication	Home	Control Box	Vehicle	Fault	Recommended Action
						
Interface fault in home	   	Blink	Off	Off	On	Improper earth connection. Check the earth pit. Short circuit between PE and phase. Error in domestic supply side. "Stop Charging"
	   	Blink	Off	Off	Blink	Proper connection of plug and socket should be ensured. Also, check socket rating and use 15A socket

Fault Category	Indication	Home	Control Box	Vehicle	Fault	Recommended Action
Control box fault	   	Off	Blink	Off	On	Contact TATA MOTORS EV Service engineer
	   	Off	Blink	Off	Blink	
Vehicle box	   	Off	Off	Blink	On	Go to nearest TATA MOTORS EV Service Centre
	   	Off	Off	Blink	Blink	

Legend



CHARGING

Maintenance of Slow Charging Gun

The Portable Charger for slow charging requires no maintenance other than occasional cleaning.

WARNING

To reduce the risk of electrical shock or equipment damage, be cautious while cleaning the connectors and case.

Clean the charging gun using a soft cloth lightly moistened with mild detergent solution. Never use any type of abrasive pad, scouring powder, or flammable solvents such as alcohol or benzene.

1. The electrical socket used for EV charging and its associated wiring should be able to supply 15A dedicated load continuously.
2. Do not use charging gun if it is wet in interface area. Allow it to dry before use.

CAUTION

Changes or modifications to this product by other than an authorized service facility may void SAE-J1772 compliance.

Action to be Taken When Charging Stops Abruptly

- Check the reason for interruption of charging. (Refer 'Troubleshooting guide for Slow Charging' table).
- Switch off the AC supply. Press the Charging Gun unlock switch on the dashboard panel to unlock the slow charging gun.
- Remove the charging gun from the charging inlet.
- Wait for 5 minutes.
- Restart the charging. (Refer charging procedure).

Cleaning of Charging Inlet

Covering the charging gun and charging inlet by dust cap will ensure protection from water and dust.

Precautions to be taken while cleaning the charging inlet

- Keep the vehicle lid always closed.
- When the lid is open ensure that dust caps are in closed position.
- During slow charging, make sure that DC charging cap is closed.
- In case of dust/mud/snow accumulation in charging port, it can be cleaned by blowing air into the charging port. Never use any water or liquid for cleaning purpose.
- Allow the charging port to dry completely.

NOTE

Water entering into the charging port will always get drained through the drain system. If water is stagnant in charging port area call TATA MOTORS Authorized EV service centre to rectify the issue.

FAST CHARGING PROCEDURE

1. Engage the parking brake. (**Charging won't start without engaging the parking brake**).

NOTE

Ensure vehicle is in OFF / Ign ON condition.



2. Pull out the Charging Gun from DC/Fast Charging Station.
3. Open the protective cap on Charging Gun.



4. Pull the 'Charging-inlet Flap Open Lever' to open the charging door.
5. Open the charger inlet flap.
6. Before connecting the charging gun to vehicle charging socket, make sure the gun lock is released.

CAUTION

If the Gun Lock is not released please don't insert the Charging Gun forcefully into the socket. It may damage the Charging Socket.

7. Remove any dust on the Charging

Gun and Charging Inlet.

8. Connect the charging gun to vehicle AC and DC Charging Inlet.
9. You hear a "click", when the Gun is connected correctly.
10. Switch on the DC charging station supply.

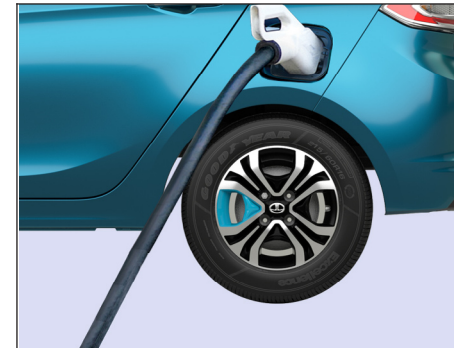

11. Charging Gun will be locked after switching on the DC charging station.

CHARGING



12. Normally the car starts charging automatically. **If not, please refer Charging Gun's Fault Indication & Indication Priority Table on the charging station.**

i NOTE

When vehicle is in Charging Mode, it will not go in Drive (D), Sport (S) or Reverse(R).

13. To know the State of Charge, Time to Charge and Gun connection status please see instrument cluster. This

status is displayed only when driver door is opened.



14. In case the park brake is not engaged or partially engaged the charging won't start and 'Engage Park Brake to start charging' message will be displayed on instrument cluster.

i NOTE

Infotainment and cabin cooling can be used during charging of the vehicle by putting the vehicle in Ignition.

15. To stop the charging, switch off DC charging station.
16. The charging gun will be unlocked 15 to 20 seconds after switching off the DC power supply as well as after pressing the fascia switch on instrument cluster.
17. Put on the protective caps on both

Charging Gun and Vehicle Inlet.

i NOTE

If you remove the charging gun from the vehicle and if you wish to reinsert the gun to recharge the vehicle, it is always advisable to put the gun back in the charger station module and then put it back for charging. A 10 sec time gap is recommended.

i NOTE

In emergency charging shutdown conditions, Gun won't be unlocked. Contact authorized TATA MOTORS EV service center.

STATE of CHARGE (SoC) GAUGE FOR HIGH VOLTAGE BATTERY

Provided in the instrument cluster as a tell-tale. It shows the charging status of the high voltage battery.

Low charge or minimum position on the indicator indicates that there is not enough energy in the high voltage battery.

Full charge or max position indicates that the HV battery is fully charged.

- When driving on highways, make sure to check in advance if the HV battery is charged enough.
- When your SoC drop below 10%, Where your tell-tale will be continuous ON and Single chime will be played to alert Low HV Battery SoC Level. further When SoC 1st bar blinks with low charger tell-tale with continuous chime it will indicate HV battery SoC is critically low.
- When the charge percentage is less than 10% in the high voltage battery, the vehicle speed is limited and the vehicle will be turned OFF once the SoC

reaches 0%. Charge the vehicle immediately.



IMPORTANT INFORMATION

Safe Driving

Safety consciousness not only ensures your safety and the safety of other road users, but also helps to reduce the wear and tear on your vehicle.

Safe driving depends on,

- How quickly you make decisions to avoid an accident.
- Your ability to concentrate.
- How well you can see and judge objects.
- How well familiar you are with your vehicle controls and its capabilities.

NOTE

Fatigue is a result of physical or mental exertion that impairs judgment. Driver fatigue may be due to inadequate sleep, extended work hours, strenuous work or non-work activities or combination of other factors. Take rest at regular intervals.

Safety Tips

- Always take into account the road conditions, weather conditions, vehicle speed in order to prevent accidents.
- Set the side indicator switch to ON at least 30 meters before taking a turn or changing the lane.
- Decrease the speed before taking turn. Do not apply brakes during cornering.
- When overtaking the vehicles, make sure that the road ahead is clear.
- Never drive under the influence of alcohol or drugs.
- If your vehicle is equipped with infotainment/navigation system, set and make changes to your travel route only when the vehicle is parked.
- Program radio presets with the vehicle parked, and use your programmed presets to make radio use quicker and simpler.

Driving in Adverse Condition

Driving Through Water

Do not drive through flooded areas. Judge the depth of water before driving through it. Otherwise, water may enter the vehicle interior or the motor compartment.

Observe water level and speed. Do not exceed the maximum water level and maximum speed; otherwise, the vehicle's motor, the electrical systems and the transmission may be damaged. Drive through calm water only and only if it is not deeper than 300mm and at this depth, maintain vehicle speed up to 15kmph.

Flowing or rushing water creates strong forces. Driving through flowing water could affect the dynamics of the vehicle. If at all the situation demands that you have to drive through water then:

Lightly apply the brake pedal to dry the liners until the brakes work normally once you are out of water.

SAFETY

WARNING

Do not attempt to start the motor if vehicle gets flooded due to water. Tow the vehicle to a safe place. Contact a nearest TATA MOTORS Authorized EV Service Centre.

Driving on a Rainy Day

Do a check of brakes, steering, windows, tyres for wear and tyre pressure. Also, do a check of wiper blades to function correctly. Avoid harsh braking and sharp turns. It may cause loss of control and lead to a skid. Keep lights ON if visibility is poor. Always drive in D mode if the road is slippery.

Driving on Wet Roads

On wet road or during light showers, "Aquaplaning" can occur. "Aquaplaning" is the loss of direct contact between the road surface and the vehicle's tires due to a water film forming between them. Steering or braking the vehicle can be very difficult, and loss of control can occur.

There is no hard and fast rule about aquaplaning. The best advice is to slow down when the road is wet.

NOTE

If you have driven for a long time in heavy rain without braking, there may be a delayed reaction from the brakes when braking for the first time. You have to press the brake pedal more firmly. Maintain a greater distance from the vehicle in front.

Night Driving

- Make sure that all lights are working and windshield, window glasses are clean.
- Drive more slowly at night than in the daytime, as the visual range is restricted at night. Maintain a speed such that you can stop within illuminated distance of head lamps.
- Do not use the high beam unless inevitable. It may dazzle the driver of the oncoming vehicle, thus causing an accident.
- Use head lamp main/dip beam to alert other road users on turns/cross roads etc.
- Use side indicators for lane change or turning.

Climbing Sharp Gradients

Apply the parking brake firmly so that the vehicle does not roll backwards.

Shift the Gear Knob lever to the "S" position. Release the brake pedal and depress the accelerator pedal gradually, and when the vehicle starts to move, release

the parking brake and depress the accelerator pedal to start off.

On climbing sharp gradients, never hold the vehicle at a stop using only the accelerator pedal or the creeping function.

Descending Sharp Gradients

Always ensure the Gear Knob is selected in either D or S or R depending on the direction. Do not shift the Gear Knob to N while descending, as reverse current from motor can damage the electronic components. Whenever need to decrease the speed press the brake as desired.

Driving on Gradients

When climbing gradient, the vehicle may begin to slow down and show a lack of power. If this happens, apply power smoothly so that there is no loss of traction.

When driving down a hill, do not drive in neutral gear or switch off the motor.

WARNING

On long and steep gradients you must reduce the load on the brakes by taking

your foot off the accelerator pedal. This allows you to take advantage of regenerative braking effect and helps avoid overheating of service brakes resulting in reduced braking efficiency.

Driving on Highway

Stopping distance progressively increases with vehicle speed. Maintain sufficient distance between your vehicle and the vehicle ahead.

For long distance driving, perform safety checks before starting a trip and take rest at certain intervals to prevent fatigue.

SEAT BELTS

This section of user manual gives the information about your vehicle seat belt, airbag and Child restraints system. Please read and follow all these instructions carefully to minimize risk of severe may cause serious or fatal injury /casualty or death.

- Seat belts are the primary restraints system in the vehicle. All occupants, including the driver, should always wear their seat belts to minimize the risk of injury.
- Sit back and adjust the front seat. Make sure that your seat is adjusted to a good driving position and the back of the seat is up-right.

Buckling the Shoulder Seatbelt

- Grasp the tongue and slowly pull out the seat belt over the shoulder and across the chest. When the seat belt is long enough to fit, put the tongue into the lock buckle until you hear a "CLICK" which indicates that the seat belt is securely locked.
- Position the lap portion of seat belt

SAFETY

across your thighs, below your abdomen. To remove slack, pull up a bit on the shoulder seat belt. To loosen the lap portion seat belt if it is too tight, tilt the tongue and pull on the lap seat belt. A snug seat belt reduces the risk of sliding under the seat belt in a collision. Make sure that the seat belt running over the body (shoulder segment and lap segment) does not have any twist. As it may not offer effective protection when required.

Releasing the Seat Belt

To release the seat belt, push the red button on the lock buckle. The seat belt will automatically retract to its stowed position. If necessary, slide the tongue down the webbing to allow the seat belt to retract fully.

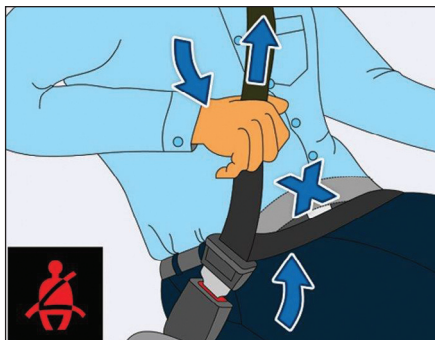

i NOTE

The above image is for reference purpose only.

Fixed Rear Center Lap Seat Belt

- When you put on the seat belt, make sure that you hear a click sound that the tab is latched into the seat belt lock. To tighten it, pull the loose end through the buckle until the seat belt is comfortably adjusted around the hips.

Seat Belt Height Adjustments (if equipped)

If the height adjustment is provided in the seat belt, occupant can adjust it to their comfort.

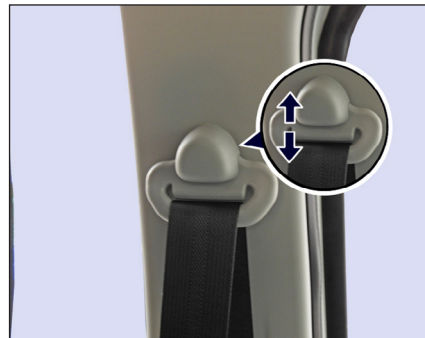

i NOTE

The above image is for reference purpose only.

⚠ WARNING

- Each seat belt assembly must only be used by one occupant. It is not recommended to put a seat belt around a child, being carried on an occupant's lap.
- Be careful not to damage or tamper the seat belt webbing or hardware. Inspect the seat belt system periodically, checking for cuts, frays, or loose parts. A frayed or torn seat belt could rip apart in a collision and leave you with no protection.
- If the seat belt webbing or hardware is damaged, get it replaced immediately at TATA MOTORS Authorized EV service centre.
- Do not put any items such as coins, clips, etc. into the seat belt buckles, and be careful not to spill liquids into these parts. If foreign materials get into a seat belt buckle, the seat belt will not work correctly.

- Do not wear seat belts over hard, sharp or fragile items in clothing, such as pens, keys, spectacles etc.
- Do not use any accessories on seat belts or modify in any way the seat belt system. Devices claiming to improve occupant comfort or reposition the seat belt can reduce the protection provided by the seat belt and increase the chance of serious injury in a collision.

Seat Belts with Pre – Tensioner (if equipped)

You can use the pre-tensioner seat belts in the same manner as ordinary seat belts.

The seat belt pre-tensioner system works in conjunction with the SUPPLEMENTARY RESTRAINTS SYSTEM (SRS-Airbags).

In the collision, pre-tensioner tightens the seat belt so that it fits the occupant's body more safely. When pre-tensioner activates, there could be some noise and release of smoke. This is usual and there are no health hazards or risk of fire.

⚠ WARNING

In a collision, the pre-tensioner seat belt assembly mechanisms become hot during activation. Do not touch the pre-tensioner seat belt assemblies for several minutes after they have been activated.

If the vehicle has been involved in a collision, get it inspected immediately at authorized TATA MOTORS EV Service Centre.

SAFETY

Seat Belt with Load Limiter (if equipped)

You can use the load limiter seat belts in the same manner as ordinary seat belts.

The seat belt load limiter system works together with the SUPPLEMENTARY RESTRAINTS SYSTEM (SRS-Airbags).

In the collision, load limiter decreases the load on the rib cage region of the occupant.

If the vehicle has been involved in a collision, get it inspected immediately at Au-thorized TATA MOTORS EV Service Centre.

Use of Seat Belts for Pregnant Woman

WARNING

- Pregnant women must wear a correctly positioned seat belt. It is safer for mother as well as unborn child.
- Pregnant women should wear the lap part of the seat belt across the thighs and as snug across the hips as possible. Keep the seat belt low so that it does not come across the abdomen. That way the strong bones of the hips will take the force if there is a collision.



Seat Belt Warning Lamp

The seat belt warning lamp reminds you to fasten the seat belt.



For Driver



For Front passenger

- If the driver does not fasten the seat belt, seat belt reminder lamp will flash and a buzzer will sound for pre-defined duration until the driver's seat belt is fastened.
- If front passenger seat is occupied by adult and does not fasten the seat belt, seat belt reminder lamp will flash and a buzzer will sound for pre-defined duration until the front passenger seat belt is fastened.
- If this system is also provided for other than Front row seats, applicable above warning will appear until seat belts are fastened.
- If front passenger seat is occupied by child, system may detect occupancy

and warn with front passenger seat belt warning. It does not mean that child can occupy front passenger seat and use a seat belt. Please refer CRS section for recommended seating position.

i NOTE

Using unauthorized aftermarket seat cover may affect function of occupant sensor. TATA MOTORS does not recommend any non-validated seat covers on seats.

CHILD RESTRAINT SYSTEM (CRS)

TATA MOTORS strongly recommends the use of Child Restraint Systems (CRS) for all children up to age of 12 years and to be placed at recommended positions only. Children travelling without recommended CRS and seated at other positions may face serious injuries in case of a collision.

CRS can be installed in the vehicle using seat belts and/or ISOFIX only (if equipped) or ISOFIX with Top Tether (if equipped).

The harness system of CRS holds the child in place, and in a collision, acts to keep the child positioned in the seat and reduce the risk if injuries.

All children below age of one year must always ride in a rear-facing infant CRS.

Keep children in a forward-facing CRS with a harness until they reach the size or weight limit allowed by your CRS manufacturer.

Once your child outgrows the forward-facing CRS, your child is ready for a booster seat.

Selection and Installation of CRS

Always select the CRS that complies with latest safety standards (AIS072 / ECE R44). The CRS are classified according to the child's size, height and weight. Select the appropriate CRS for your child. Ensure that the child fits properly in the CRS and it is securely installed in the vehicle. For installation, please refer CRS manufacturer's instruction manual.

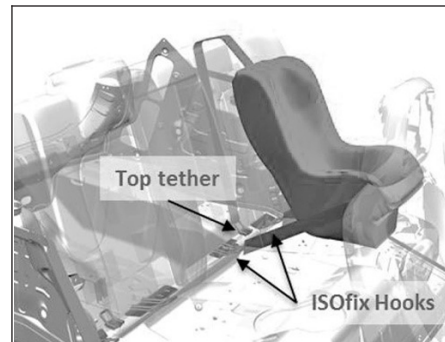

SAFETY

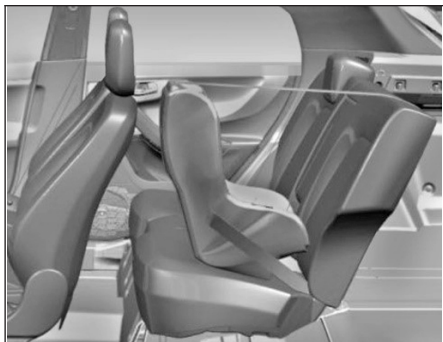

NOTE

The above images are for reference purpose only.

Recommended CRS Position as per the Vehicle Matrix

The suitability of seat position for carriage of children and recommended category of CRS is shown in the table below as per the child group.

X - Seat Position is not suitable for children in this age group.

U - Suitable for “universal” category restraints approved for use in this age group.

Universal is a category in the AIS072 / ECE R44 norm.

Group	Mass Group	Age Group	Front Passenger	Rear Out-board Lh	Rear Out-board Rh	Rear Center
0	Upto to 10 kg	Up to 9 months	X	U	U	X
0+	Upto to 13 kg	Up to 24 months	X	U	U	X
I	9 to 18 kg	9 months to 48 months	X	U	U	X
II	15 to 25 kg	Approx. 3 to 7 years	X	U	U	X
III	22 to 36 kg	Approx. 6 to 12 years	X	U	U	X

WARNING

If a child is seated in the front seat it may cause serious injury or even death during any collision.

SAFETY

WARNING

If your vehicle is equipped with a front passenger air bag (PAB) and does not have PAB deactivation switch, do not install a rear facing CRS in the front passenger seat. If the PAB inflates, a child in a rear facing CRS could be serious injured or killed.

If you install a CRS in the rear seat, slide the front seat far enough forward so that the child's feet does not touch the front seatback. This will help avoid injury to the child in the event of a collision.

WARNING

- Children could be endangered in a collision if their CRS are not properly secured in the vehicle. Be sure to secure the child in the restraint system according to the manufacturer's instructions.
- Do not use an infant carrier or a child safety seat that "hooks" over a seatback, it will not provide sufficient

protection in a collision.

After a collision, we recommend to get seat belts, seats, ISOFIX and top-tether anchorages (as may be applicable) investigated at TATA MOTORS Authorized EV service centre.

NOTE

A CRS in a closed vehicle can become very hot. To prevent burns, check the seating surface and buckles before placing your child in CRS.

WARNING

- Do not leave unattended children in your vehicle.
- Do not modify CRS in any way.

NOTE

- *Do not install a booster seat or a booster cushion with only the lap strap of the seat belt.*
- *Do not install a booster seat or a booster cushion with a seat belt that is slack or twisted.*
- *Do not put the safety seat belt under your child's arm or behind its back.*
- *Do not use pillows, books or towels to boost your child's height.*
- *Make sure that your children sit in an upright position.*
- *Do not allow children to stand up or kneel on either the rear or the front seats. An unrestrained child could suffer serious or fatal injuries during a collision.*
- *Do not leave any toys or other objects loose in the CRS or on the seat while the vehicle is in motion.*

Each CRS should be used for one child only.

If the airbag SRS warning indicator in the instrument cluster illuminates continuously, it means that there is malfunction in the system. Remove the CRS from front passenger seat and contact your TATA MOTORS authorized EV service centre.

i NOTE

The images shown are for reference purpose only.



SAFETY

SUPPLEMENTARY RESTRAINT SYSTEM (SRS) (Airbags)

The airbag 'SRS' system contain the following components depend upon the provided safety features in vehicle.

- Seat belt pre-tensioners
- Seat belt with load limiters
- Driver Airbag
- Front Passenger Airbag
- Airbag 'SRS' ECU (Electronic Control Unit)
- Collision Sensors
- SRS wiring harness
- SRS warning lamp

The System is active when ignition switch is in the "ON" position or the ignition mode is "ON". Air bags are designed to inflate in collisions when required. In the event of a collision, the collision sensors will detect signals, and if the Airbag ECU judges that the signals represent a severe collision, will trigger the airbags. The inflated air bags provide a cushion to the occupants. The air bag inflates and deflates so quickly

that you may not even realize that it has activated. The air bag will neither hinder your view nor make it harder to exit the vehicle.

Airbag inflation is virtually instantaneous and occurs with considerable force, accompanied by loud noise and smoke, which is usual. The inflated airbag, together with seat belts, limit the movement of an occupant, thereby reducing the risk of injury.

When an airbag inflates, you may see some smoke-like particles. The particles are a normal by-product of the process that generates the non-toxic gas used for airbag inflation. These airborne particles may irritate the skin, eyes, nose, or throat. If you have skin or eye irritation, rinse the area with water. For nose or throat irritation, move to fresh air. Also sometimes the smoke can cause breathing problems, it is advised to get fresh air immediately.

After inflation, airbag gradually gives a cushioning effect for the occupant after which it deflates. It is not advisable to drive your vehicle after the airbags have been

deployed. If you are involved in another collision, the airbags will not be in place to protect you.



i NOTE

The above image is for reference purpose only.

i NOTE

- *Open your windows and doors as soon as possible after collision to reduce prolonged exposure to the smoke and powder released by the inflating Airbag.*
- *Do not touch the Airbag container's internal components immediately after an Airbag has inflated. The parts that come into contact with an inflating Airbag may be very hot.*
- *Always wash exposed skin areas thoroughly with lukewarm water and mild soap.*

The driver airbag is mounted in the center of the steering wheel. The front passenger airbag is located inside the dashboard in front of the passenger seat. The vehicle fitted with the airbags have suitable indications on steering wheel and on dashboard. The word 'SRS' is embossed on the airbag covers.

⚠ WARNING

- Even in vehicles with airbags, passengers must always put on the seat belts. In order to minimize the risk and severity of injury in the collision.
- Always use seat belts and CRS – during trip. Even with air bags, this can cause injury or death in the collision. If you put on improperly seat belt or not using seat belt when the air bag inflates.
- Do not sit or lean close to the air bags.
- Move your seat as far back as possible from front airbags, while still maintaining control of the vehicle.
- All occupants should sit upright with the seatback in an upright position, centered on the seat cushion with their seat belt on, legs comfortably extended and their feet on the floor until the vehicle is parked and the IGN is turned off.

- If an occupant is out of position during collision, then quickly deploys air bag may hit the occupant causing serious or fatal injuries.
- Do not let the front passenger to put their feet or legs on the dashboard.
- Do not let the passenger to ride in the front seat when the front passenger air bag OFF indicator is illuminated.

Wrong Seating Position

SAFETY



 NOTE

The above image is for reference purpose only.

 WARNING

- Never place your arm over the airbag area as a deploying airbag can result in serious arm fractures or other injuries.
- Do not place or stick any items in the vehicle, except at designated locations (such as utility bins, cup/bottle holders, boot space etc). Loose items may act as projectiles during a collision and cause severe to fatal injuries.
- Please be aware that any unsecured item in your vehicle, such as your pet, unsecured CRS or a laptop, can become a potential hazard in the event of a collision or sudden stop, causing injuries to occupants in the vehicle.
-

- Coat hooks if provided, must be used only for that purpose. Never hang other items on to those hooks. This could affect deployment of airbags and may lead to severe or fatal injuries.
- ALWAYS contact your TATA MOTORS Authorized EV Service Centre if the vehicle is damaged, even if airbag has not inflated.
- ALWAYS contact your TATA MOTORS Authorized EV Service Centre if any part of an airbag module cover shows sign of cracking or damage.

 WARNING

- Never make any modifications to your vehicle. The modifications carried out, but not limited to the vehicle frame, bumpers, front fenders, ride height, suspension, seat belts, interior trims, steering wheel (especially holders), are not acceptable. This will affect the intended perform

ance of SRS.

- Fitment of bull bars, seat covers on seats with airbags etc, is strictly prohibited, unless authorized by TATA MOTORS. This will affect the intended performance of SRS.
- If you need to make any modifications to accommodate any disability you may have, please contact your TATA MOTORS Authorized EV Service Centre for necessary guidance.
- Do not tamper with SRS in any way. This will lead to unexpected performance of system and may cause serious injury or death.

SAFETY

WARNING

If your SRS malfunctions, the airbag may not inflate properly during a collision thereby increasing risk of serious injury or death. If any of the following conditions occur, your SRS is malfunctioning:

- The SRS warning lamp does not turn 'ON' when the ignition switch is placed in the 'ON' position for few seconds.
- The SRS lamp stays ON after illuminating.
- The SRS warning lamp comes 'ON' and stays 'ON' while the vehicle is in motion.
- The SRS warning lamp blinks when the motor is ON.

We recommend the customer to immediately visit TATA MOTORS Authorized EV Service Centre and get the SRS system inspected if any of the above conditions occur.

Airbag Warning Sticker on Front Passenger Sun Visor



The Airbag Warning Symbol on sun visor reminds extreme hazards associated with the use of rearward-facing child restraint on front passenger seat during airbag deployment.

It does not mean that a child can occupy front passenger seat and use seat belt. Please refer CRS section for recommended seating position for children.

WARNING

Do not use a rearward facing child restraint on a seat with by an active airbag in front of it. Death or serious injury to the child can occur.

Airbags Deployment Conditions

When the front airbags should not deploy?

Minor frontal collision: Seat belt (if fastened) offers adequate occupant protection in low severity collisions. The airbags are deployed only when there is a collision severe enough to trigger the airbags. Deployment of frontal airbags is not beneficial in low severity collisions.

Side collision: During a side collision, occupants tend to move sideways. Therefore, deploying frontal airbags in such situations will not benefit the occupants.

Rear collision: During a rear collision, occupants tend to move (rearwards) away from frontal airbags. Therefore, deploying frontal airbags in such situations will not benefit the occupant protection. Head restraints and seat belts (if fastened) provide occupant protection during a rear collision.

Rollover collision: During a rollover collision, occupants not wearing seatbelts may float inside the passenger compartment. This will increase the risk of injuries and may prove to be fatal. Wearing seat

belts provide highly effective occupant protection during rollover collision. Front airbags are not designed to deploy in a rollover as frontal airbags cannot offer any protection in rollover collision.

When do front airbags deploy with minor or no visible vehicle damage to the car?

The airbags are triggered only when there is a collision severe enough to trigger the airbags. The extent of vehicle damage is not always the correct indicator for airbag deployment. In some extreme/rare conditions of rough road driving or running into a curb or hitting other fixed objects, the airbags may deploy depending upon the severity of collision. In some of these cases, the damage to the vehicle may be minor or not be readily visible.

Why front airbags do not deploy, even with exterior visible vehicle damage to the car?

The airbags are triggered only when there is a collision severe enough to trigger the airbags. The amount of visible vehicle damage is not always the correct indicator for airbag deployment. Some collisions can result in visible damage but with no airbag deployment, because the airbags would not have been needed or would not have provided protection even if they had deployed. Seat belts, if fastened, offer adequate occupant protection in such cases.

SAFETY

CHILD LOCK

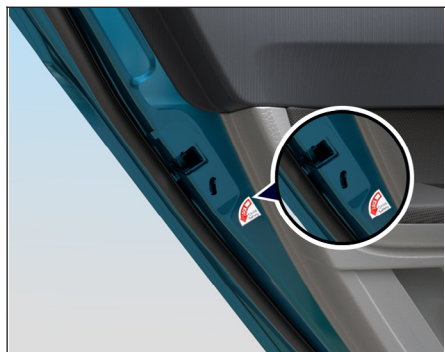

The rear doors of the vehicle have child proof locks. Push the lock lever located on vertical face of the door downward before you close the door. The door which is locked by activating the child lock cannot be opened from the inside. It can be opened only from the outside.

NOTE

- *Lift the lock lever upward to deactivate the childproof lock when not required.*
- *Child safety lever is used for safety of child. When child seat in the passenger seat, child lock prevent the child to open the rear door. It also prevent the accident while vehicle is running.*

ANTI-THEFT DEVICE- IMMOBILIZER / PEPS (if equipped)

Immobilizer system is designed to prevent vehicle theft by electronically disabling the ignition system. The EV can be started only with vehicle's original Immobilizer ignition key which has an electronic identification programmed code.

NOTE

Use only Flip key, the other should be kept in a safe location. Note down "key Tag no." information (and keep it safe) which is required while getting new/spare keys. Remember that it is not possible to prepare new/spare keys without the "key Tag number." Keep the Flip key safely because without it, the vehicle cannot be started.



Vehicle Condition	Immobilizer Lamp Status	Vehicle State	Meaning / Function Of The State
Ignition OFF	Blinking	Locked	Vehicle Immobilized and awaiting electronic key
Ignition ON	OFF	Unlocked	Normal condition and ready to start the vehicle
Ignition ON	ON	Locked	- Problem with key (Wrong key used to start vehicle) - Problem with Immobilizer system. Contact the TATA MOTORS Authorized EV Service Centre
Ignition ON	Blinking	Unlocked	Contact the TATA MOTORS Authorized EV Service Centre immediately

SAFETY

ANTI-LOCK BRAKING SYSTEM (ABS)

ABS regulates brake pressure in such a way that the wheels do not lock when you brake. This allows you to continue steering the vehicle when braking.



The ABS warning lamp in the instrument cluster lights up for few seconds when the ignition is turned on. It turns off when the motor is ON.

WARNING

- If ABS is faulty, the wheels could lock when braking. The steer ability and braking characteristics may be severely impaired. There is an increased danger of skidding and accidents.
- Drive on carefully. Have ABS checked immediately at a TATA MOTORS Authorized EV Service Centre as soon as possible.

While Braking

- In case of emergency braking, press the brake pedal fully. This allows the ABS to regulate braking force and maintain directional control of vehicle.
- When ABS is active driver may feel brake pedal pulsating and very low (ABS) motor activation noise from engine compartment which is normal during braking.

WARNING

- ABS may not shorten the distance in all situations
- ABS system will have the effect of increased stopping distance due to conditions such as gravel, pot holes, slippery surfaces, wet road, ground covered with snow etc.
- Travelling on bad road, panic braking brake pedal may become hard this is due to ABS system taking control. ABS will not compensate for bad road, weather conditions and poor driving judgment. Always drive carefully in adverse weather and traffic condition. Always keep safe distance and adhere to speed limits

ELECTRONIC BRAKE FORCE DISTRIBUTION (EBD) (if equipped)

EBD monitors and controls the brake pressure on the rear wheels to improve driving stability while braking.



EBD provides optimal braking pressure distribution between front and rear wheels to optimize braking distance and to ensure vehicle stability by means of lowering braking pressure increase at rear wheels.

Centre as soon as possible.

WARNING

- In the case of EBD failure the driver will be alerted via the symbol on instrument cluster.
- If EBD is malfunctioning, the rear wheels can lock, e.g. under full braking. This increases the risk of skidding and an accident.
- You should therefore adapt your driving style to the different handling characteristics. Have the brake system checked immediately at a TATA MOTORS Authorized EV Service

KEYS

An E-key is an electronic access and authorization system which is provided as a standard feature on your vehicle.

Unlocking Principle

The transponder which is built into the ignition E-key carries a unique identification code. The vehicle unlocks when the code on the E-key matches with the code on the Vehicle Control Unit (VCU).

Vehicle Starting

When the key is engaged and the ignition is switched 'ON', all codes are communicated within E-key, Immobilizer and VCU. The car will start only if all the codes match.

Loss of Keys



If you cannot find the key, contact the nearest TATA MOTORS Authorized EV Service Centre immediately.

WARNING

- Do not turn 'ON' ignition switch by using E-key with any type of metal wound around its grip or in contact with it. This may be detected as unusual condition by immobilizer and prevent car from starting.
- Do not leave the E-key in areas of high temperature. The transponder in it will behave abnormally when reused.
- Do not try to start the vehicle when the Immobilizer indicator lamp on the instrument cluster is glowing. In this condition the vehicle will not start and the vehicle's battery will also be drained due to frequent cranking.

OPENING AND CLOSING

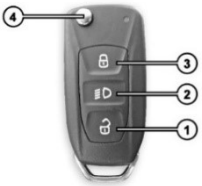
Keys (if equipped)

Sr. No.	Name	Remote Key	Description
1	Mechanical key		<ol style="list-style-type: none">1. Locking all doors2. Unlocking all doors
2	Flip key with remote		<ol style="list-style-type: none">1. Unlocking all doors2. Approach light3. Locking all doors4. Folding key blade in/out
3	Smart Key (PEPS)		<ol style="list-style-type: none">1. Locking all doors2. Approach light3. Unlocking all doors4. Tail gate opening

the key blade inside.



i NOTE

Key Blade should not be folded without pressing the button. Also, it should not be forced in any direction apart from folding direction to avoid damage to Flip Mechanism.

Manual Operation of Central Door Locking / Unlocking

All doors can be locked / unlocked operating driver door using either key blade from outside or knob from inside.

FLIP KEY

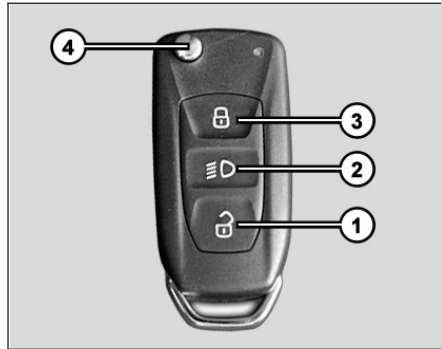

1. Unlock
2. Approach Light / follow me / Trunk lid
3. Lock
4. Key blade in / out button

Unlocking all Doors

To unlock all doors, press unlock push-button (1) once. Unlocking will be confirmed by single flash of turn indicators.

Approach Light / Follow Me

Press approach light button (2) once, low beams, potion lamps and roof lamp will turn 'ON'. This feature helps to find and reach the parked vehicle or to reach home in dark/ cloudy condition after parking. To switch 'OFF' the approach lights, press and release the same button or it automatically turns 'OFF' after approx. 30 seconds.

Trunk Lid Opening (if equipped)

Electric trunk lid opening can be done through long press (4 sec) approach light button on remote key.

Locking all Doors

To lock all doors, press lock push-button (3) once. Locking will be confirmed by two flashes of turn indicators.

If lock button is pressed on the remote key with the driver door open, locking-unlocking takes place with audible warning sound. If any other door is open, the vehicle gets locked but indicators do not flash.

Folding Key Blade in / out

Press button (4) to flip out the key blade. For folding, press the button (4) and fold

OPENING AND CLOSING

SMART KEY (if equipped)

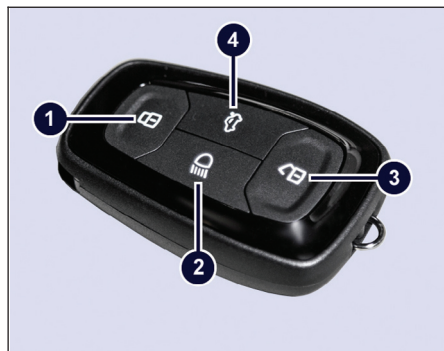

Keep the smart key with user to perform the passive access. It is used for locking, unlocking and starting the vehicle.

1. Locking all doors
2. Approach light
3. Unlocking all doors
4. Tail gate opening

Locking all Doors

Press the lock button once (1) to lock all the doors of the vehicle.

Successful lock will be indicated by two

flashes of turn signal indicators.

Approach Light

This feature helps to find and reach the parked vehicle.

When you press approach light button (2) once, low beam, roof lamp and position lamps will turn 'ON'.

This feature helps to find and reach the parked vehicle or to reach home in dark/ cloudy condition after parking.

To switch 'OFF' the approach lights, press and release the same button or it automatically turns 'OFF' after approx. 30 sec

Unlocking all Doors

Press the unlock button once (3) to unlock all the doors.

Successful unlock will be indicated by one flashes of turn signal indicators.

Tail Gate Opening

Press the tail gate opening button once (4) to unlock the tailgate with in authentication range of Smart key i.e. 1 to 1.5 meters.

NOTE

If smart key battery is low/drained or vehicle battery is low/drained, user can unlock and enter into vehicle by using mechanical key blade, which is present inside the smart key.

Key Blade in / out



Slide the knob (1) to release the key. Pull the key blade (2) out.

SMART KEY FEATURES

Vehicle Search

If lock button on smart key is pressed when the vehicle is locked, the turn indicators of vehicle flashes four times for the driver to locate the vehicle.

Automatic Activation Of Immobilizer

If the smart key is not found within the passenger compartment, power electronics and drive unit will be immobilized and vehicle cannot be started.

Auto Lock/unlock of Doors/ Auto Re-lock (drive Away Locking)

In case of PEPS variants, door will get unlocked when ignition is OFF by pressing start/stop button.

Vehicle doors get automatically locked when all doors are closed and the vehicle speed crosses 10 kmph.

Also, when unlocked with remote key and if no door is opened within 30 seconds, vehicle doors get automatically locked.

Vehicle doors get automatically locked after 180 sec time lapse, when vehicle

power is in OFF mode and vehicle all doors in locked condition. After doing other than driver door transition (open a closed) then vehicle all doors will get unlocked and an audio warning will be sounded for 9 sec to alert that the key is inside the vehicle.

Anti-grab / Anti-scan Coding

The remote control set of this security system is protected against the use of devices called 'scanners' and 'grabbers' that can record and reproduce some types of remote codes.

Important

- Don't press unlock button on remote in the vicinity of your vehicle, as you may accidentally unlock your vehicle.
- For battery replacement procedure, refer 'MAINTENANCE' section.
- Don't remove the battery connection of the vehicle while the vehicle has been locked by remote.

Smart Key Precautions

1. If smart key is close to radio transmitter, it may interfere with the operation of the smart key.
2. If the smart key is near a mobile two way radio system or a cellular phone, then it will not work correctly.
3. If another vehicle's smart key is being operated close to your vehicle, the signal will fluctuate.

WARNING

Keep the smart key away from electromagnetic materials which block electromagnetic waves to the key surface.

NOTE

In case any button of the key is accidentally pressed for more than 20 seconds, the remote stops functioning till the time the button is pressed. The LED on the Remote also stops glowing. The function of the remote gets reinstated immediately when the user stops pressing

OPENING AND CLOSING

the push button of remote.

Force Panic Operation

Force Panic ON Operation

When the vehicle is in off condition and the lock and unlock buttons are pressed at the same time, the force panic operation becomes active. In this case, the turn indicators start flashing and the vehicle starts to honk.

Force Panic OFF Operation

To deactivate the force panic operation, press any button on the smart key.

Vehicle Alarm & Security

To prevent automobile thefts, the anti-theft system makes use of an anti-theft alarm (ATA). On detection of any unauthorized access, the BCM triggers the horn (acoustic alarm) and flashes the turn indicators.

Two Smart Keys Scenarios

Sr. No	Scenarios	Precondition	Action	PEPS Behavior
1	One smart key is inside the vehicle (away from Immobilizer antenna) and other smart key is outside the vehicle within authentication range.	Vehicle is in OFF mode and all doors closed	Lock the vehicle with outside smart key (passive lock / RKE lock) and keep outside smart key away from authentication range.	When user tries to start the vehicle with inside smart key, vehicle doesn't start.
2	One smart key is inside the vehicle (near Immobilizer antenna) and other smart key is outside the vehicle within authentication range.	Vehicle is in OFF mode and all doors closed.	Lock the vehicle with outside smart key and keep outside smart key away from authentication range.	When user tries to start the vehicle with inside smart key, vehicle would start with back up start. User presses start/stop button twice with the interval of 2.5 sec between two presses within 5 seconds. Note: The vehicle doesn't start if inside smart key is kept away from Immobilizer antenna until vehicle is unlocked by outside smart key via outside door handle OR RKE unlock command from inside/outside smart key is received.
3	One smart key is inside the vehicle (near Immobilizer antenna) and other smart key is outside the vehicle within authentication range.	Vehicle is in OFF mode and all doors closed.	Lock the vehicle with outside smart key and keep outside smart key away from authentication range.	When user tries to unlock/lock the vehicle ((RKE lock / unlock) with inside smart key, RKE lock/ unlock operation takes place normally.

OPENING AND CLOSING

Sr. No	Scenarios	Precondition	Action	PEPS Behavior
4	One smart key is inside the vehicle (away from Immobilizer antenna) and other smart key is outside the vehicle within authentication range.	Vehicle is in OFF mode and all door closed.	Lock the vehicle with outside smart key (passive lock / RKE lock) and then unlock the vehicle with mechanical key.	When user tries to start the vehicle with inside smart key, vehicle doesn't start. However, RKE operations (lock/unlock) take place normally.
5	One smart key is inside the vehicle (away from Immobilizer antenna) and other smart key is outside the vehicle within authentication range.	Vehicle is in ACC/IGN mode and all doors closed.	Lock the vehicle with internal knob.	When user tries to unlock the vehicle passively with outside Smart key (from driver/co driver side), vehicle doesn't get unlocked in ACC/IGN mode. Also, when user tries to unlock the Tail gate passively, Tail gate doesn't get unlocked.
6	One smart key is inside the vehicle (away from Immobilizer antenna) and other Smart key is outside the vehicle within authentication range.	Vehicle is in ACC/IGN mode, all doors closed, and vehicle is in unlock state.	Keep the outside smart key within driver door vicinity and try to lock vehicle with driver door handle switch from driver / co driver side.	Vehicle doesn't get locked in ACC / IGN mode.

DOORS

Door Lock and Unlock with Key (if equipped)

The front doors can be locked or unlocked from outside using the key blade.

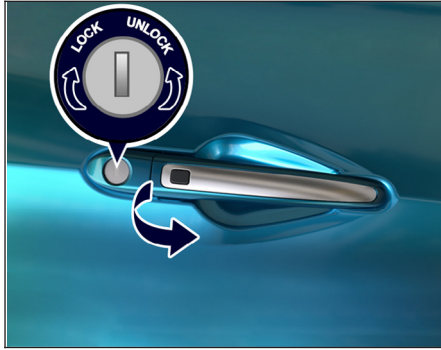

Insert the key in the slot and turn it clockwise to lock and anticlockwise to unlock the door.

Door Locking and Unlocking using Door Handle Switch (DHS)

To lock/unlock all the doors without operating smart key button/ key blade. Press

the door handle switch (DHS) provided on the driver door to lock/unlock all the four doors excluding Tail gate.

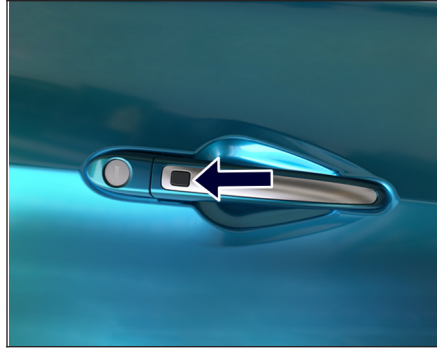

i NOTE

- *Authentication range for smart key ranges from 1 to 1.5 meters from outside the respective door or tail gate.*
- *Passive entry works only when ignition is off.*

Locking without a Key from Inside (if equipped)

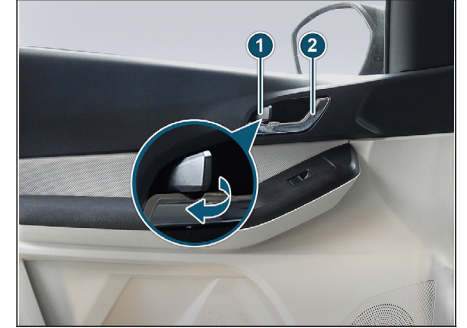

All the doors can also be locked from inside by pressing knob (1) on driver door and independently on other doors respectively.

Opening the Doors from Inside

All doors can be opened from inside. To open, pull the door opening knob (1) and then lever (2).

i NOTE

OPENING AND CLOSING

There is a single pull override feature on driver door. All door can be unlocked by inner handle without operating lock knob of inner handle.

WINDOWS

Power Window (if equipped)

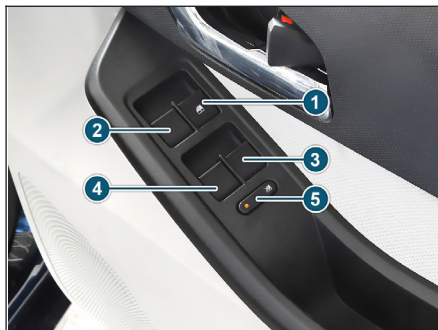

1. Front Window Winding Switch (Right)
2. Front Window Winding Switch (Left)
3. Rear Window Winding Switch (Right)
4. Rear Window Winding Switch (Left)
5. Inhibit Switch

Window glasses on all four doors can be operated by switches provided on the main control panel located on the driver's arm rest. They work only when the key is in the 'IGN ON' position.

i NOTE

Power windows can be operated within 30 sec of 'IGN OFF' and 'KEY OUT' positions, provided that doors are closed.

Express Down (if equipped)

Window glasses can be opened by a single long press of the switch. Express down feature is provided for the driver's door only.

Individual Switches (if equipped)

Individual window winding switches have been provided on the front passenger and rear doors.

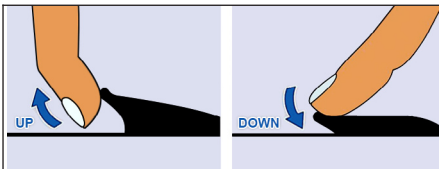

Glasses are wound up or down by pulling or pressing the switch.

WARNING

While raising the glass, take care to avoid fingers/hands getting trapped between glass and the door frame.

Inhibit Switch (if equipped)



When switch is pressed, red light turns 'OFF'. The individual switches provided on other doors are not functional. It can be only operated by driver side switch.

As the switch is depressed red light turns ON and individual switches became functional.

WARNING

- If children operate the windows they could get trapped, particularly if they are left unsupervised. There is a risk of injury.
- Activate the window inhibit feature when children are travelling. When leaving the vehicle, always take the key with you and lock the vehicle. Never leave children unsupervised in the vehicle.

OPENING AND CLOSING

BONNET

Opening

WARNING

Always switch off the ignition before opening the bonnet.

1. Make sure that the vehicle is in neutral position with the parking brake applied.
2. Pull the bonnet release lever. The bonnet will pop up slightly.



3. Raise the bonnet slightly and with your finger slide the secondary lock lever located under the bonnet centre to the left side.

NOTE

Make sure that the wiper arms are not raised before you lift up the bonnet to avoid damaging the wiper arms and the bonnet.

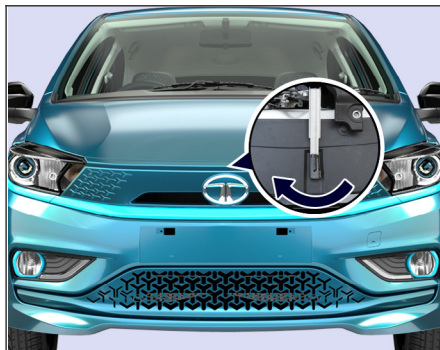

4. Lift the bonnet up. Pull the bonnet stay rod from its clip and engage the free end into the slot.

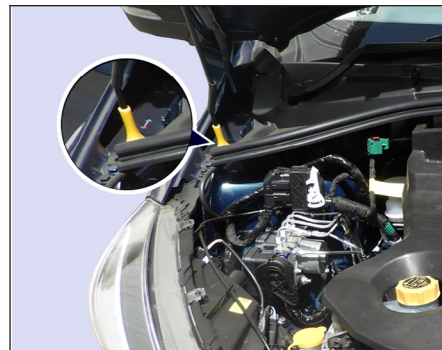

WARNING

Put the stay rod into the hole securely. If the rod drops off, your body may be caught below the bonnet.

Closing

1. To close the bonnet, hold the bonnet by one hand, disengage the stay rod and clamp it back properly.
2. Lower the bonnet close to the bumper, and then let it drop down.

WARNING

Make sure that the bonnet is locked properly before driving or it can fly up unexpectedly during driving.

TAILGATE OPENING

PEPS Key (if equipped)

Option 1



To release the tailgate, press the tail gate button on the remote.

Option 2



Press the button available below the chrome garnish to open the Tailgate.

OPENING AND CLOSING

Option 3



To open the tailgate press the switch located on fascia switch.

Flip Key (if equipped)

Option 1



Press and hold approach light button for few sec until the tailgate is unlock.

Option 2

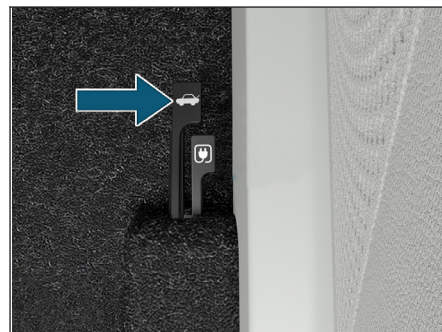

Pull the lever located at right side below near to driver seat to open the tailgate.

i NOTE

For other key type, use key for opening the tailgate.

OPENING CHARGING PORT FLAP



To release the Charging port flap, pull the lever located at the right hand side below the driver seat.

Remove the Rubber Cap for charging before gun insertion and place it back after charging.

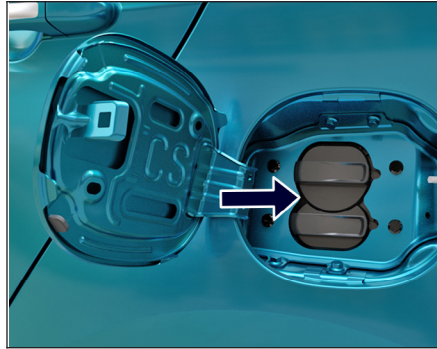

NOTE

- *If charge cap needs replacement, make sure that it is replaced by a genuine cap at the TATA MOTORS Authorized EV Service Centre.*

DASHBOARD AND FEATURES

COCKPIT

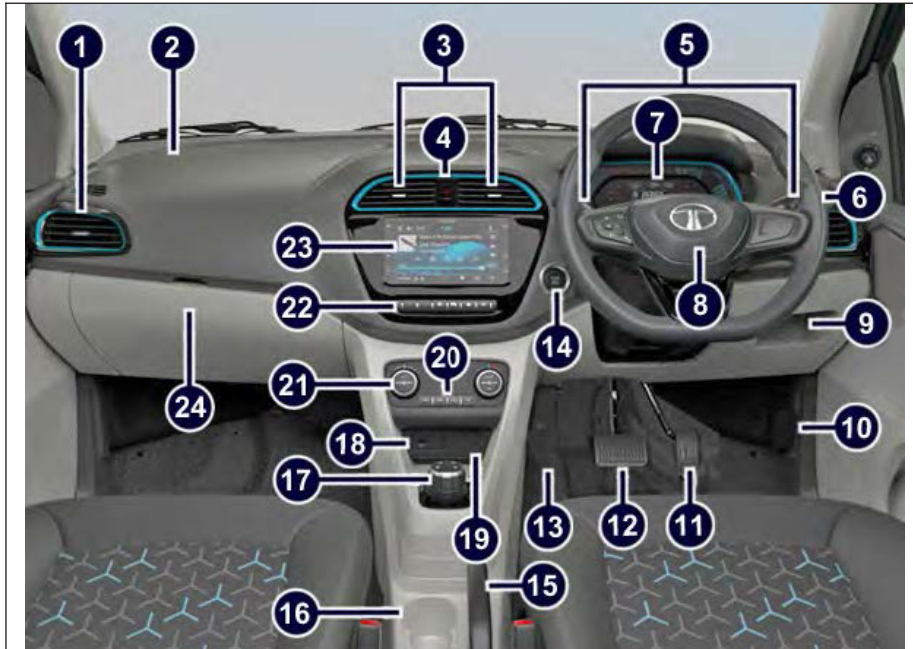

1	A.C. Air vent (Side)
2	Air Bag (PAB)

3	A.C. Air vent (Middle)
4	Hazard Warning Switch
5	Combi-Switch
6	Steering Wheel
7	Instrument Cluster
8	Horn pad / Air Bag (DAB)
9	Driver side pocket
10	Bonnet switch
11	Accelerator Pedal
12	Brake Pedal
13	Foot Rest
14	Start stop switch - if fitted
15	Parking Brake Lever
16	Cup Holder
17	Gear Selection Knob
18	USB/AUX Port - if fitted
19	Power Socket
20	FATC Switches
21	FATC Control Panel
22	Fascia Switches
23	Infotainment System - if fitted
24	Glove Box

DASHBOARD AND FEATURES

INSTRUMENT CLUSTER



NOTE: All indicators show may not be applicable to your vehicle.

DASHBOARD AND FEATURES

State Of Charge (SoC)



SoC Gauge indicates the State of Charge remaining in battery in percentage.

NOTE

At every key in and Ignition ON, SoC Gauge needle moves to MAX and comes back to '0' position. This is a welcome strategy and self-check feature.

Speedometer



Speedometer indicates the vehicle speed in km/h.

NOTE

At every key in and Ignition ON, speedometer digits moves from 0 to 199 and returns to 0. This is a welcome strategy and a self-check feature.

EV Mode Gauge

This function provides instantaneous power consumption mode of vehicle during driving and displayed in the instrument cluster.

During the IGN ON of the vehicle, EV mode gauge will starts sweep from ECO mode from Minimum to Maximum and then Power mode from Minimum to Maximum and coming back from Maximum to Minimum from Power to ECO mode to indicate the welcome strategy behavior.

Drive

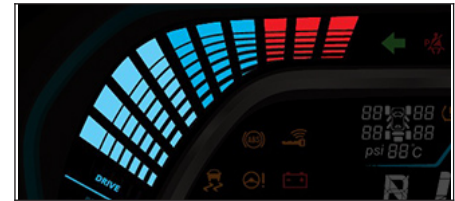

This function provides instantaneous power consumption mode of vehicle during driving and displayed in the instrument cluster.

During the IGN ON of the vehicle, EV

DASHBOARD AND FEATURES

mode gauge will starts sweep from ECO mode from Minimum to Maximum and then Power mode from Minimum to Maximum and coming back from Maximum to Minimum from Power to ECO mode to indicate the welcome strategy behavior.

ECO Mode

In ECO mode, the ECO band will fill as per the power consumed in ECO drive by taking instantaneous power consumption input.

Power Mode

In Power mode, Power band will fill as per power consumed in Power drive by taking instantaneous power consumption input.

Regeneration Mode



In regeneration mode, regeneration band will fill as per energy recuperation while

driving by taking instantaneous power consumption input.

NOTE

When all functional modes are activated, then take the vehicle to TATA authorized service centre.

Regen Level Gauge







This function provides Regeneration Level settings to user from Minimum to Maximum in steps of Level 0, Level 1 & Level 2 of vehicle during driving and displayed in the instrument cluster.

The “Maximum” Regen Level setting provides the maximum amount of re-generative braking power & it recaptures the most energy and reduces wear & tear on the brakes.



The “Minimum” Regen Level setting incorporates a reduced regenerative braking force that recaptures less energy but allows the vehicle to coast farther than in the “Maximum” Regen Level.

Sr. No.	Regen Selection Through Switch	Regen Levels On Instrument Cluster Display
1.	OFF	
2.	LEVEL 1	
3.	LEVEL 2	
4.	LEVEL 3	

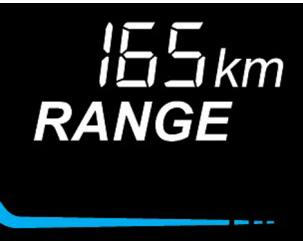

Driver Information System

Driver Information	System Image	Description
Odometer		Indicates total distance travelled by a vehicle. The Odometer reading does not return to “0” when it reaches maximum value, the display will freeze to maximum value and not resettable.
Tripmeter A& B	 	The trip meter is used to measure the distance travelled on short trips. It can be reset to “0”. Trip meter reading becomes “0.0” after it crosses 9999.9 kms.
Average energy consumption for Trip A and Trip B	 	Indicates “Average Energy consumption” that your vehicle consumed during the trip A and Trip B. NOTE: <i>When Average energy consumption value displays - - Wh/ km instead of integer value, then take the vehicle to TATA MOTORS authorized EV Service Centre.</i>



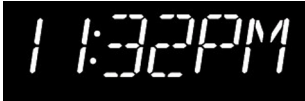

DASHBOARD AND FEATURES

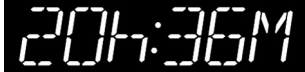



Driver Information	System Image	Description
Distance to empty		<p>Indicates approximate distance that your vehicle can travel with available usable battery charge left in battery & it is displayed in “km”. This value may differ from the actual driving distance available.</p> <p>NOTE: If RANGE is displayed as ‘—’, take your vehicle to authorized TATA MOTORS EV Service station.</p> <p>The distance to empty value is an estimate of the available driving distance. In event of drive with higher power consumption / harsh drive, actual initial RANGE shown and kilometer driven will vary than display.</p>
Service reminder		<p>Indicates the number of days or kilometers remaining for next service at every ignition ON for few seconds if service is due. If service is overdue, DIS will display 0 km or 0 days and spanner symbol shall blink at every ignition ON for few seconds.</p> <p>DIS will indicate Spanner symbol as continuously ON when service is overdue.</p> <p>When Service reminder warning appears, take your vehicle to Authorized TATA MOTORS EV Service station.</p> <p>NOTE: The service reminder through instrument cluster is just for an indicative purpose. Please refer the Maintenance and Service</p>

DASHBOARD AND FEATURES



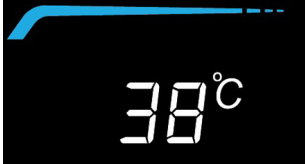

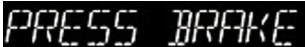

Driver Information	System Image	Description
		<p>section in owner's manual for extensive information on service schedules.</p>
Clock		<p>When the ignition switch is in the "ON" position, it shows the time.</p> <p>NOTE: You can change the clock time using SET and MODE buttons.</p> <p>Whenever the battery terminals or related fuses are connected you must reset the clock time. This feature is available when ignition switch is in ON position.</p>
Night time illumination control		<p>Instrument cluster illumination in night time can be controlled in 5 steps as per your convenience using SET and MODE button.</p>
TIME TO CHARGE (TTC)	<p>TIME TO CHARGE</p> 	<p>Indicates approximate time to charge for complete Charging of Battery. It indicates in "HH:MM" (Hours: Minutes). This value may vary based on the various vehicle parameters.</p> <p>NOTE: Time to charge screen comes only in charging ON and IGN OFF condition for 30 Sec and 5 Sec for every interruption.</p>







DASHBOARD AND FEATURES

Driver Information	System Image	Description
Door ajar (if equipped)		<p>All four doors and tail gate are indicated independently when respective door or tail gate is open. NOTE: If any other door is open roof lamp will be 'ON' provided that roof lamp switch is in position</p>
		<p>This warning will be indicated when driver door is open. NOTE: <i>If any other door is open roof lamp will be 'ON' provided that roof lamp switch is in position.</i></p>
Vehicle status display		<p>Indicates the vehicle is in run mode and ready to move.</p>
Gear for display		<p>Indicates the current drive mode of the vehicle, will be displayed on DIS. NOTE: <i>If display shows 'F or Blank' take your car to TATA Authorized EV Service Centre.</i></p>





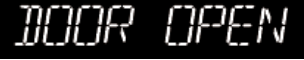

Driver Information	System Image	Description
Outside ambient temperature		<p>Indicates the outside ambient temperature of FATC System from 'LO' to 'HI'. Displays outside ambient temperature in units °C. and Resolution is 1°C.</p> <p>NOTE:</p> <ol style="list-style-type: none"> 1. The temperature sensor is in the front bumper of the vehicle, therefore the temperature reading can get affected by heat reflection from the road surface, Power electronics and Drive unit heat, the exhaust from surrounding traffic etc. <i>This can cause an incorrect temperature reading when the vehicle is under low speeds or when stopped.</i> 2. <i>If display shows '- -', take your car to TATA Authorized EV Service Centre.</i>
Charging level		Indicates the charging level of the battery in Percentage.
KEY BATT LOW		"KEY BATT LOW" text warning comes 'ON' for 4 seconds when UID key battery is low.
KEY OUT OF RANGE		"KEY OUT OF RANGE" text warning comes 'ON' for 4 seconds when UID key is not inside the vehicle.
PRESS BRAKE TO CRANK		"PRESS BRAKE TO CRANK" text warning comes 'ON' for 4 seconds when BRAKE is not pressed to crank the vehicle.



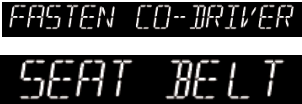



DASHBOARD AND FEATURES

Driver Information	System Image	Description
SERVICE DUE		"SERVICE DUE" text warning comes 'ON' for 4 seconds when service is overdue.
OVER SPEED		"OVER SPEED" text warning comes 'ON' for 4 seconds when display speed crosses 120 Km/Hr.
TAKE A BREAK		"TAKE A BREAK" text warning comes 'ON' for 4 seconds when driver drives continuously for prolonged duration. NOTE: "TAKE A BREAK" text warning comes 'ON' for 4 seconds again with specific duration if vehicle is not stopped and continuously driven.
HAPPY BIRTHDAY		"HAPPY BIRTHDAY" text warning comes 'ON' for 4 seconds on owner's birthday.
BATT TEMP HIGH DRIVE SLOW		"BATT TEMP HIGH DRIVE SLOW" text warning comes 'ON' for 4 seconds when HV Battery Temperature is high.
MOTOR TEMP HIGH DRIVE SLOW		"MOTOR TEMP HIGH DRIVE SLOW" text warning comes 'ON' for 4 seconds when Motor Temperature is high.
HV BATTERY LOW PLEASE RECHARGE		"HV BATTERY LOW PLEASE RECHARGE" text warning comes 'ON' for 4 seconds when there is Low State of Charge.

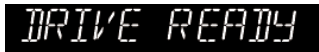

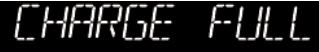
Driver Information	System Image	Description
		
HV CRITICAL ALERT		"HV CRITICAL ALERT" text warning comes 'ON' for 4 seconds when there is critical alert in HV System.
LIMITED PERFORMANCE		"LIMITED PERFORMANCE" text warning comes 'ON' for 4 seconds when Limited Performance Mode Activated.
ENGAGE PARK BRAKE TO START CHARGING		"ENGAGE PARKBRAKE TO START CHRGING" text warning comes 'ON' for 4 seconds when Vehicle Charger is connected.
WELCOME		"WELCOME" text warning comes 'ON' for 4 seconds when Ignition is changed from OFF to ON.
DOOR OPEN		"DOOR OPEN" text warning comes 'ON' for 4 seconds when any Door is open.
PARK BRAKE ALERT		"PARK BRAKE ALERT" text warning comes 'ON' for 4 seconds when vehicle speed is above 5 Kmph and park brake is engaged.

DASHBOARD AND FEATURES

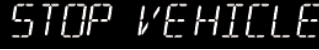
Driver Information	System Image	Description
FASTEN DRIVER SEAT BELT		"FASTEN DRIVER SEAT BELT" text warning comes 'ON' for 4 seconds when driver seat belt is not fasten and vehicle speed is above 15 Kmph.
FASTEN CO-DRIVER SEAT BELT		"FASTEN CO-DRIVER SEAT BELT" text warning comes 'ON' for 4 seconds when co-driver seat belt is not fasten and vehicle speed is above 15 Kmph.
AUX BATTERY LOW		AUX BATTERY LOW text warning comes 'ON' for 4 seconds when auxiliary battery is low.
ACCESSORY ON		ACCESSORY ON text warning comes 'ON' for 4 seconds when Accessory vehicle power mode is ON.
IGNITION ON		IGNITION ON text warning comes 'ON' for 4 seconds when Ignition vehicle power mode is ON.
STEER FAIL VISIT SERVICE CENTER		STEER FAIL VISIT SERVICE CENTER text warning comes 'ON' for 4 seconds when steering system fails.
STEER FAIL STOP DRIVE		STEER FAIL STOP DRIVE text warning comes 'ON' for 4 seconds when defect found in steering System.

Driver Information	System Image	Description
DRIVE READY		DRIVE READY text warning comes 'ON' for 4 seconds when Vehicle is ready to drive.
CHARGER CONNECTED		CHARGER CONNECTD text warning comes 'ON' for 4 seconds when Vehicle Charger is connected.
CHARGE NOT FULL BAT SOC XX PERNT		CHARGE NOT FULL BAT SOC XX PERNT text warning comes 'ON' for 4 seconds when Vehicle Charger is Removed & Battery is not Fully Charge.
CHARGE FULL		CHARGE FULL text warning comes 'ON' for 4 seconds when vehicle charging is full.
PARK BRAKE SWITCH FAULT VISIT SERVICE CENTRE		PRK BRK SW FAULT VISIT SERV CENT text warning comes 'ON' for 4 seconds when park brake switch is in fault state.
MALFUNCTION VISIT SERVICE CENTRE		MALFUNCTION VISIT SERV CENT text warning comes 'ON' for 4 seconds when there is malfunction in system.
IGN OFF TAKE KEY OUT		IGN OFF TAKE KEY OUT text warning comes 'ON' for 4 seconds when Ignition is OFF.
STOP VEHICLE TO SHUT- DOWN		"STOP VEHICLE TO SHUTDOWN" text warning comes 'ON' for 4 seconds when PEPS System in fault state.

DASHBOARD AND FEATURES

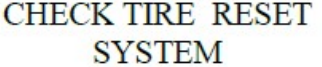
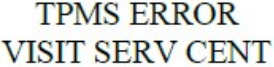
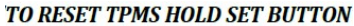
Driver Information	System Image	Description
		
LOW SOC S MODE DEACTIVATED		"LOW SOC S MODE DEACTIVATED" text warning comes 'ON' for 4 seconds when S drive mode is selected with vehicle battery low condition.
iTPMS Warning-Text Warning (if equipped)		"CHECK TIRE RESET SYSTEM" text warning comes 'ON' for 4 seconds when any tire pressure is high / Low in vehicle tires.
iTPMS Warning-Text Warning (if equipped)		"TPMS ERROR VISIT SERV CENT" text warning comes 'ON' for 4 seconds when there is any fault in iTPMS System.
iTPMS Warning-Text Warning (if equipped)		"TO RESET TPMS HOLD SET BUTTON" text warning comes 'ON' for 4 seconds when TPMS reset active request from ABS ECU.

Distance to Empty (RANGE)

RANGE indicates approximate distance (km) that the vehicle can travel with current charge.

RANGE shall be indicated both in IGN ON & IGN OFF conditions.

This value may differ from the actual driving distance.

'RECHARGE' shall be displayed which indicates that it's the time to take your vehicle to the nearest charging station.

i NOTE

If RANGE is displayed as '—', then take your vehicle to TATA MOTORS Authorized EV Service Centre.

Instrument Cluster Illumination



For Instrument Cluster illumination level settings, turn the Park Lamp 'ON' and then Press the 'SET' knob on instrument cluster.

Press 'SET' knob to change the illumination intensity at 5 levels. A delayed press on the 'SET' knob for a selected intensity will confirm it.

⚠ WARNING

The Clock and Instrument Cluster Illumination settings must be done only when the vehicle is in stationary condition for safety purpose.

DASHBOARD AND FEATURES

Driver Information Settings

Screen flow of Instrument cluster

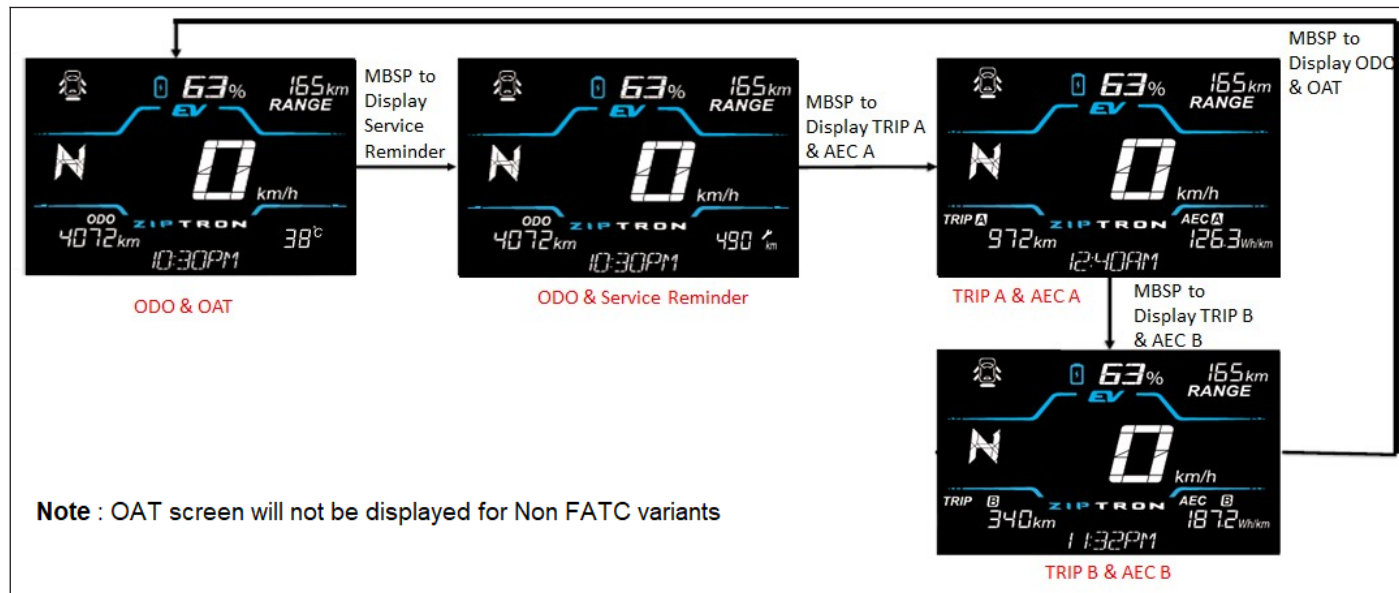



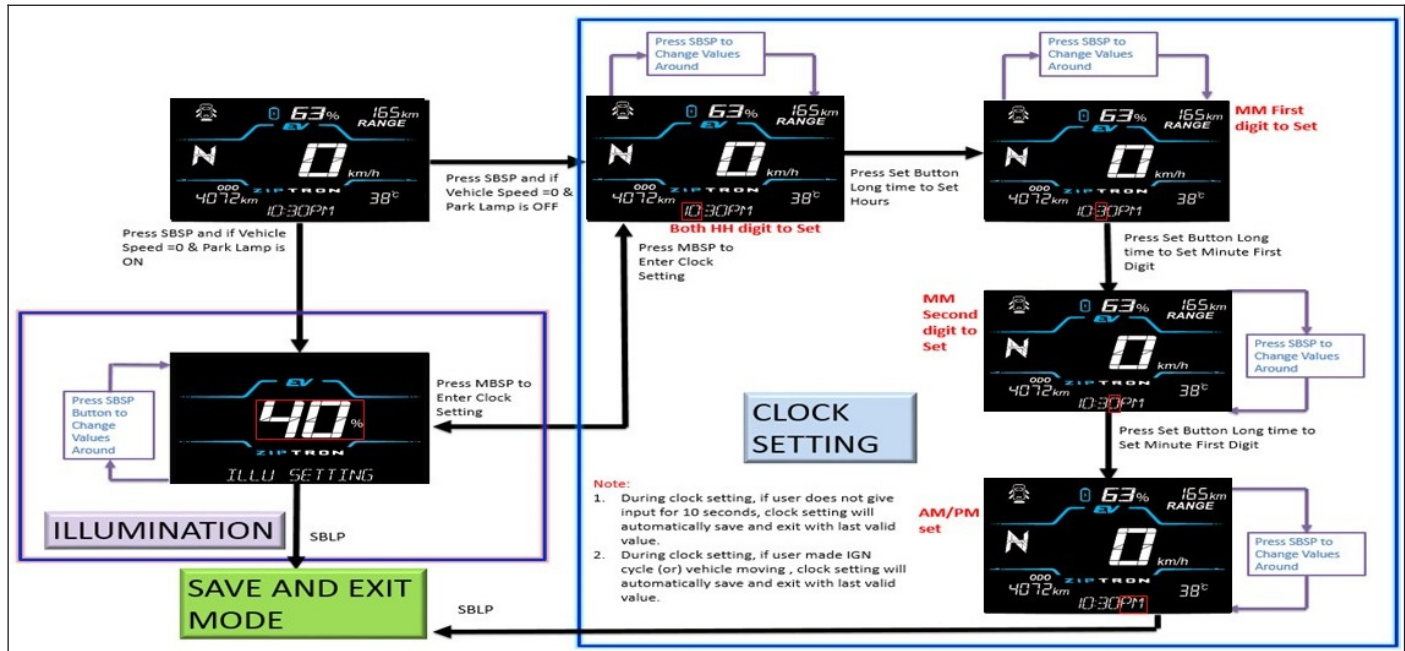

Clock Setting





DASHBOARD AND FEATURES





WARNING LAMPS

Warnings Lamps	Color	Indicator	Remarks
Turn Signal	Green		Indicates direction indicated by the turn signal. Blinks along with buzzer while operating left/right turn indicator only when ignition is switched 'ON'.
High Beam	Blue		Illuminates when the high beam headlamps are switched 'ON' or flashed.
Immobilizer	Red		<ol style="list-style-type: none">1. Illuminates when the system disables vehicle, start if the original key is not used.2. Lamp blinks: Vehicle is in immobilized condition when key is not engaged.3. Lamp ON: Problem with key/system. Contact a TATA MOTORS Authorized EV Service Centre.
LV Battery Charging	Red		This symbol indicated Low Voltage Level of Auxiliary (12V) battery System & lights up when the 'IGN' is turned 'ON' for 4 Sec & goes OFF after Power electronics and Drive unit start. It will continuously illuminate when there is malfunction of charging system. Contact a TATA MOTORS Authorized EV Service Centre.
EPAS	Amber		Illuminates momentarily when ignition is switched 'ON'. Illuminates when there is a fault in the EPAS. Contact a TATA MOTORS Authorized EV Service Centre immediately.



DASHBOARD AND FEATURES

Warnings Lamps	Color	Indicator	Remarks
Park Brake / Brake Fluid Low	Red		<p>Illuminates momentarily when ignition is switched 'ON'. Once parking brake is released, it turns 'OFF'. If it remains 'ON', it indicates</p> <ol style="list-style-type: none"> 1. Brake fluid level is low 2. Park brake is applied & turns 'OFF' when it is released
Driver Seat belt indicator	Red		<p>Driver Seatbelt Reminder The driver seatbelt warning indicator comes ON for 4 seconds, when ignition is turned ON The warning lamp remains ON as long as the driver seatbelt is not fastened. If the seatbelt remains unbuckled and vehicle goes 15 Km/h then final warning audio chime will start and continue for 90 seconds. Note: Once the seatbelt is fastened the buzzer and warning lamp goes OFF. Seatbelt reminder remains OFF when reverse gear is engaged.</p>
Airbag status	Red		<p>Illuminates when ignition is switched 'ON' and goes 'OFF' in approx. 4 seconds. If it continuously illuminates or blinks then contact the TATA MOTORS Authorized EV Service Centre immediately.</p>



DASHBOARD AND FEATURES

Warnings Lamps	Color	Indicator	Remarks
Charging indicator	Green		This features provides HV battery charging status to user. Whenever the IGN is ON, this telltale glows for a few seconds and goes off. The telltale shall remain ON irrespective of the Input state during these few seconds. This tell-tale shall be controlled turned ON/OFF by receiving the charging input signal. This Telltale is ON during charging.
Key not detected	Amber		This symbol lights up when the Valid UID (User Identification Device) is not detected inside the vehicle.
AC ON/OFF	Blue		Illuminates momentarily when ignition is switched 'ON'. This indication will 'ON' when the FATC is turned 'ON' & will remain 'OFF' when the FATC is turned off.
Front Passenger Seat belt indicator	Red		Front Passenger Seatbelt Reminder The co-driver seatbelt warning indicator comes ON for 4 seconds, when ignition is turned ON The warning lamp remains ON as long as the co-driver seatbelt is not fastened.





DASHBOARD AND FEATURES

Warnings Lamps	Color	Indicator	Remarks
			<p>If the seatbelt remains unbuckled and vehicle goes 15 Kmph then final warning audio chime will start and continue for 90 seconds.</p> <p>Note: Once the seatbelt is fastened the buzzer and warning lamp goes OFF. Seatbelt reminder remains OFF when reverse gear is engaged.</p> <p>Occupant Detective System An occupant detection sensor is installed in the front passenger seat to detect whether the seat is occupied or not. The sole purpose of this sensor is to issue seat belt reminder warnings for the front passenger seat. The sensor does not have any control on the deployment of airbags.</p> <p>WARNING: Any modification in the seat material or addition of seat cover may damage or affect the performance of the sensor.</p>
DRL indication	Green		This symbol lights up when the 'IGN' is turned 'ON' and shall go 'OFF' a few moments. This symbol comes ON when the Day Time Running lamp is 'ON'.
Motor High Temperature telltale	Red		This feature provides traction motor high temperature status to user. This telltale shall be controlled turned ON/OFF by receiving the input motor high temperature input signal, whenever Motor temperature is high it will indicate the user EV system motor high temperature and to visit service center.

DASHBOARD AND FEATURES

Warnings Lamps	Color	Indicator	Remarks
Speed limit warning indicator	Amber		<p>Speed Limit warning indicator comes 'ON' for a few moments, when ignition is turned 'ON'. When Vehicle Speed cross 80 kmph then Speed Limit Warning Indicator will turn ON along with audio warning every two minutes.</p> <p>If Vehicle Speed crosses 120 kmph then along with Speed Limit Warning Indicator, audio warning will remain on until the vehicle speed is above 120 kmph.</p> <p>Once Vehicle Speed comes below 120 kmph but is still above 80kmph, then a continuous beep (audio warning) will stop but Speed Limit Warning Indicator will be ON continuously with audio warning once in two minutes.</p> <p>When vehicle speed is below 80kmph, then Speed Limit Warning Indicator along with audio warning is OFF.</p>
Limp Home mode tell-tale	Amber		<p>This features provides vehicle limp home mode indication to user. Whenever the IGN is ON, this telltale glows for a few seconds and goes off. The telltale shall remain ON irrespective of the Input state during these few seconds. These telltale turns ON to indicate the user, EV system with limited performance mode is getting activated to caution user to take necessary safety measure.</p>
HV Critical Telltale	Red		<p>This features provides vehicle high voltage system critical alert indication to user. Whenever the IGN is ON, this telltale glows for a few seconds and goes off. The telltale shall remain ON irrespective of the Input state during these few seconds. When HV side error signals happens then telltale will turn ON to indicate the user EV system criticality and to contact service center.</p>

DASHBOARD AND FEATURES

Warnings Lamps	Color	Indicator	Remarks
Press Brake	Amber		Press Brake Telltale is used to indicate the driver to hold the Brake while using Start /Stop button to start the vehicle. Whenever the IGN is ON, this telltale symbol will light up for a few seconds and then go off. The telltale shall remain ON irrespective of the Input state during these few seconds.
Charger Connected	Blue		This feature provides HV (High voltage) battery charger connection status. The Telltale comes ON when charger is connected. The lamp comes ON for 4 sec when the IGN is turned ON.
ABS indicator	Amber		When Ignition is turned 'ON', this symbol comes 'ON' for a few moments and goes 'OFF'. This symbol shall continue to remain 'ON' if there is a problem in the ABS system. If the warning is continuously ON Take your Car to TATA MOTORS Authorized EV Service Centre.
Zero Charge/ Low Charge	Red		This features provides High Voltage battery status to user. Whenever the IGN is ON, this telltale glows for a few seconds and goes off. The telltale shall remain ON irrespective of the Input state during these few seconds. This telltale shall be controlled turned ON/OFF by receiving the SoC input when the SoC level is low telltale will turn ON to indicate charging system battery low to the user.
Battery High Temperature Telltale	Red		This features provides HV battery high temperature status to user. Whenever the IGN is ON, this telltale glows for a few seconds and goes off. The telltale shall remain ON irrespective of the Input

DASHBOARD AND FEATURES

Warnings Lamps	Color	Indicator	Remarks
			state during these few seconds. This tell-tale shall be controlled turned ON/OFF by receiving the input HV battery high temperature input signal , whenever battery temperature is high it will indicate the user EV system battery high temperature and to visit TATA MOTORS Authorized EV Service Centre.
iTPMS	Amber		iTPMS warning indicator comes 'ON' for 4 seconds, when ignition is turned 'ON'. Then it will turn OFF, It remains for 4 seconds when any tire pressure is high / Low in vehicle tires. iTPMS warning indicator will blink for 10 sec along with audio for error.

AUDIO REMINDERS (as equipped)

Key in Reminder/audio Warning

If you forget the key inside the vehicle when you leave the ignition in 'OFF' position, an audio warning will sound. Remove key to stop the warning.

If no Key is Detected in the Vehicle

If the vehicle is in ACC ON/IGN ON and the customer takes the smart key out of the vehicle and closes the last door, an audio warning will be sounded for nine times to alert that the key is not in the vehicle.

NOTE

In this condition customer needs to bring the smart key inside the vehicle.

Parking Lamp 'ON' Reminder

If you forget to turn OFF the parking lamp, an audio warning will be started. Switch OFF the parking lamps to stop the warning.

NOTE

Do not forget to turn OFF your park lamp as it may drain the vehicle's battery.

Parking Brake 'ON' Reminder

If Parking Brake is engaged and vehicle is driven, telltale will turn ON and buzzer provides audible warning if vehicle speed is above 5 km / hrs continuously.

NOTE

Disengage the parking brake to stop audible warning.

Driver Seat Belt Reminder

If seatbelt is not fastened and vehicle goes above 15 kmph, then final audio warning will go more than 90 seconds. Seat belt telltale light will remain continuously ON when audio alarm is active.

Front Passenger Seat Belt Reminder

If front passenger has not fastened seatbelt and if vehicle speed goes above 15kmph, then final audio warning will go

more than 90 seconds. Seat belt telltale light will remain continuously ON when audio alarm is active.

NOTE

Fasten the seatbelt to stop audio warning.

Steering Wheel Locked Chime

If steering wheel is locked in the vehicle, then sound warning will be given to alert user.

Turn Indication Hazard Warning ON

If any of the turn indication or both turn signal are ON, tick tock chime shall sound.

Speed Limit Chime

If speed goes above defined threshold (120kmph) Buzzer will sound to alert user, chime sounds continuously till the speed comes down to the normal limit(<80kmph).

High Temperature Alert for Battery

When maximum battery cell temperature crosses the limit specified, buzzer will start along with the battery high temperature TT blinking to indicate the user to contact

DASHBOARD AND FEATURES

service centre.

TT and buzzer will be in sync continuously till the state remains TRUE.

High Temperature Alert for Motor

When machine and inverter temperature crosses the max limit from the BMS, buzzer will start along with the motor high temperature TT blinking to indicate the user to contact service center.

TT and buzzer will be in sync continuously till the state remains TRUE.

Low Battery Charging Chime

When Auxiliary battery charging fault occurs with high criticality, buzzer will start along with the TT blinking to indicate the user to contact service centre.

TT and buzzer will be in sync continuously till the state remains TRUE.

EV Limp Home Mode

When SoC percentage crosses the limit then TT will get activated to indicate EV system with limited performance so that user shall take the necessary safety actions. During which, buzzer will start along with the TT blinking to indicate the user to

contact service center. TT and buzzer will be in sync continuously till the state remains TRUE.

Gear Shift Denied Chime

When Gear Shift denied triggers to user, then sound warning will be given to alert user.

Hand Park Brake ON Reminder at Ignition OFF

When Ignition is turned OFF and Hand Brake is not engaged with Drive Door Open then buzzer will provide audible warning to alert user.

NOTE

Engaging the park brake to stop audible warning.

Key Fob Battery Low Chime

When battery of vehicle key fob is low, then sound warning will be given to alert user.

PEPS Key not Detected Chime

If PEPS key is not detected in the vehicle, then sound warning will be given to alert

user.

Gear Indication

If gear changes, buzzer shall sound for every iteration.

Gear Indication buzzer is the one time buzzer to give information about the GSS current mode position.

Reverse Gear Reminder

If reverse gear is engaged buzzer shall sound to alert user.

Charging ON Park Brake OFF Chime

When charger is connected & Park brake is disengaged, then sound warning will be given to alert User.

Regen Level Chime

When driver change the regen level through Regen level switch, then sound warning will be given to alert User.

HV Critical Fault Chime

When vehicle high voltage system critical alert happens, then sound warning will be given to alert the user.

iTPMS Chime

If iTPMS alert condition occurs, iTPMS chimes shall sound for 4 sec.

COMBI SWITCH (RH STALK)

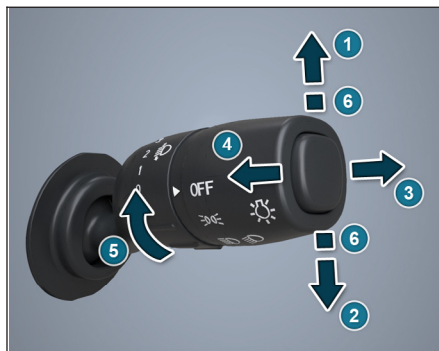

Right Turn Signal

Move the lever fully downward.

i NOTE

When the turn is completed, the signal will cancel and the lever will return to its normal position.

High Beam

Move the lever forward to select the high beam function.

Pull the lever back to normal for low beam.

High Beam Flash (spring return)

To flash the high beam, pull the lever towards you from the normal position. It will return to its normal position when you release it.

Headlamp Rotary Switch

OFF Position

All lamps will remain 'OFF'.



Parking Lamp

Rotate stalk to turn 'ON' the Parking lamps.



Low Beam

Rotate stalk to turn 'ON' the low beam function.



Auto Light (if equipped)

The headlights will be automatically switched ON. Depending on ambient light conditions (while entering a tunnel or when it is twilight).



Lane Change Signal

To change a lane, move the lever slightly

DASHBOARD AND FEATURES

up or down to the point where the turn signal light begins to flash for six times, but the lever does not latch. The turn signal will flash six times automatically.

Day Time Running Lamps

Day time Running Lamps (DRL) are used to increase the visibility of the vehicle to other drivers during daytime.



1. To activate and deactivate DRL, keep the ignition switch in 'ON' position and switch the parking lamp ON-OFF twice.
2. Activation and Deactivation of DRL can be done by DRL soft switch, which is available on the Infotainment Display.

Head Lamp Levelling Rotary Switch

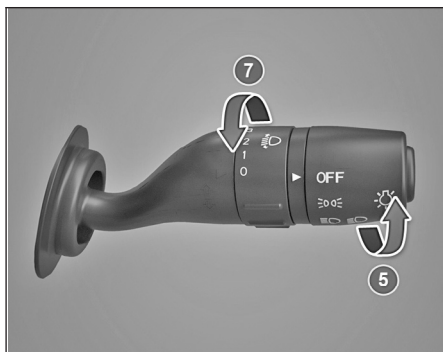

Inner rotary switch on right hand stalk is provided for head lamp leveling. With the inner rotary switch, Head lamp leveling can be done with head lamp in Low Beam and in 'ON' position. Select correct position before start of trip, when the vehicle is stationary. Depending on the number of passengers and luggage in the vehicle headlamp focus may change. This can be adjusted by rotating the knob to one of the three level positions.

COMBI SWITCH (LH STALK) (if equipped)

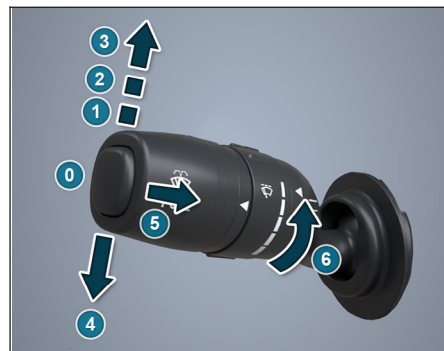

'OFF' Position

The wiper is switched 'OFF'.

Intermittent Wipe

Push the stalk upwards to operate intermittent wipe.

Inner rotary switch on left hand stalk is provided for intermittent front wiper delay. The switch has five delay timers. Push the stalk towards position (1)



for single wipe.

Slow Wipe

Push the stalk towards position (2) for continuous slow wipe.

Fast Wipe

Push the stalk towards position (3) for continuous fast wipe.

Flick Wipe (spring return)

Pull the stalk downwards and hold it for continuous wipe, the wiper continuously wipes across the windshield at low speed till the stalk is released.



Front Windshield Washer

- Pull the lever little longer, to spray the washer fluid on the windshield.
- The windshield wipers will operate for three cycles after the lever is released and for one more cycle after five seconds.



NOTE

When you crank the vehicle, the supply to washer motor is momentarily cut off.

Rear Wash and Wipe

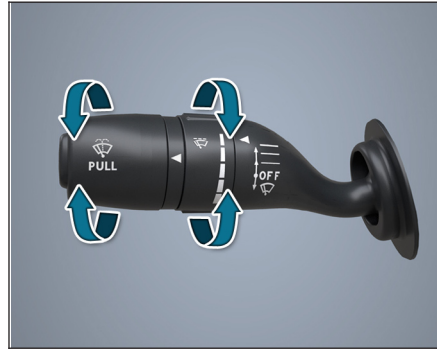

Rear Windshield / Wiper and Washer (spring return)

Turn the rotary knob clockwise and release to operate rear windshield wash and wipe. The windshield wipers will operate for three cycles.



Rear Wipe

Turn the rotary knob counter clockwise such that it aligns its positions with arrow mark to operate rear windshield wiper continuously.



NOTE

Rear wiper will not work as long as tail gate is open.

Rear Windshield/ Wiper and Washer Switch

Turn the rotary knob counter clockwise such that it aligns its positions with the arrow mark and hold it to operate rear windshield wash and wipe function. It will return to 'Rear wipe' position as soon as it is released and continues to wipe.



DASHBOARD AND FEATURES

NOTE

When you reverse the car with front wipers in 'ON' condition, the rear wiper will also be 'ON' (if provided).

WARNING

If you operate wash and wipe function for more than 15 seconds the controller cuts off the supply to the washer motors to avoid overheating.

DASHBOARD CONTROLS

Option 1



1. Regen Switch-Level Down
2. Regen Switch-Level Up
3. Front Fog Lamp Switch
4. Charger Gun Lock/Unlock
5. Center Locking Switch
6. Tail Gate Opening Switch

Option 2



1. Charger gun lock unlock
2. Centre door lock-unlock

DASHBOARD AND FEATURES

Option 3



1. Charger gun lock unlock

Regeneration Switches

Regen Switch - Level Down



Regen Switch - Level Up



- During decelerating or braking condition of vehicle, regeneration converts the available kinetic energy to electrical energy which charges the High Voltage battery.
- Regeneration level for the vehicle can be controlled manually or can be turned off.
- Level down switch can be used to reduce the regeneration level (3 to 2 to 1 to OFF).
- Level up switch can be used to increase the regeneration levels (OFF to 1 to 2 to 3).
- Default regeneration level on vehicle

when vehicle is cranked will be Level 1.

- Regeneration will be reduced automatically when the high voltage battery is fully charged to prevent overcharging.
- During coasting as the vehicle decelerates, the rear brake lamp will turn ON in a manner similar to when brake pedal is pressed. This is to alert the vehicles behind you that your vehicle's speed is decreasing.

Front Fog Lamp Switch (if equipped)



Front fog lamp is located on front bumper. In conditions where visibility is poor due to fog, snow or rain, the fog lamps improve visibility as well as making it easier for other road users to see you.

DASHBOARD AND FEATURES



It turns 'ON' when the front fog lamp switch is pushed in with ignition 'ON' and position and parking / head lamp is 'ON'. An indicator on the switch will be illuminated when the front fog light is 'ON'.

Charger Gun Lock Unlock (if equipped)



Charging socket inlet is located at Rear LH side of vehicle in fuel flap. It is mandatory that the charging gun should be locked

with CCS 2 inlet during the charging process. Charging gun unlock switch is used to unlock the actuator present in CCS type 2 inlet to allow charging cable to be taken out.

NOTE

Make sure both AC slow charging & DC fast charging is De-energised / off state.

Central Door Lock/unlock Switch (if equipped)



To open the door, press the switch located on the fascia switch.

Tail Gate Opening Switch (if equipped)



To unlatch the tail gate, press the switch located on fascia switch.

STEERING MOUNTED CONTROLS (LHS) (if equipped)



Seek Forward / Backward

Press above switch to change radio channels or move between media tracks.



Source

Press above switch to select the required source in the infotainment system i.e. USB, AM, FM and Bluetooth.



DASHBOARD AND FEATURES

STEERING MOUNTED CONTROLS (RHS) (if equipped)



Volume

Press above switch to increase or decrease volume of music system / radio.



Mute / Phone Reject

Press above switch to reject or hang up a phone call. It is also used to mute the volume of music system/radio.



Receive Calls/PTT (push to talk)

Press above switch to accept incoming call when a cell phone is connected via Bluetooth.



Voice Recognition

To start, press the voice activation button provided on the steering wheel. The system mutes/ pauses the currently played audio and you will hear a beep sound to indicate the activation of the voice recognition feature. The system displays the Voice Recognition screen on Infotainment to indicate activation of the feature.

Voice Recognition only works when An-

droid Auto, Apple CarPlay is connected.

i NOTE

The system will start recognizing your voice command only after the beep. So, speak your command only after you hear the voice activation beep.

i NOTE

For more information refer. <https://cars.tatamotors.com>

Horn Button

Press to operate the horn.

i NOTE

For more information on steering wheel switches refer Infotainment manual.

Cruise Control Master Switch

Cruise speed can be resumed only if cruise control is deactivated by applying the brake. To resume the previously set cruise speed, accelerate the vehicle to a speed is as per gear selected as



DASHBOARD AND FEATURES



below:

3rd gear approx. 30Kmph to 80Kmph



4th gear approx. 40kmph to 120Kmph

5th gear approx. 50kmph to 140Kmph

Cruise Set (Reset) Using Speed Increase (Decrease) Switch

- Press the 'Cruise control master switch'  on steering wheel.
- Accelerate the vehicle to the desired speed.
- Make sure that the Brake pedals are not pressed.
- Press the 'Speed decrease/Set'  switch on steering wheel switch to set the desired cruise speed. The cruise control indicator on instrument cluster will turn 'ON'.
- Remove your foot from the accelerator pedal. Once Cruise control is activated the vehicle automatically maintains the stored speed.

Changing The Set Cruise Speed

- The set cruise speed can be adjusted using the switches 'Speed increase/Resume' (to increase)  or 'Speed decrease/Set' (to decrease)  on steering wheel.
- The speed increases and decreases on a single press.
- The changed speed will be shown on the speedometer.
- Keeping the switch pressed increases or decreases the speed continuously till the switch is released or maximum/minimum speed limit is reached.
- The set speed can also be increased by pressing the accelerator pedal till the desired speed is achieved and then pressing the 'Speed decrease/Set'  switch.
- The set speed can also be decreased by pressing the brake pedal (The cruise indicator will turn OFF) and slowing down to desired speed and

then pressing the 'Speed decrease/Set'  switch (The cruise control indicator will turn 'ON' again).

Cruise Control Deactivating Switch

- There are two ways to deactivate cruise control:
- Applying brake.
- Press 'Cruise control deactivating' switch  on Steering Wheel.

NOTE

For more information, refer infotainment manual. Refer link - <https://cars.tatamotors.com/>

MIC (if equipped)

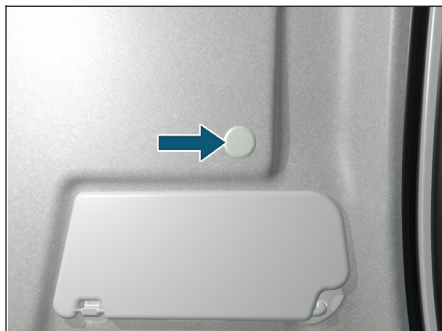

Mic is provided above the driver seat on roof.

INFOTAINMENT SYSTEM DISPLAY (if equipped)

Option 1



Option 2



NOTE

- For more information, refer infotainment manual. (Refer link - <https://cars.tatamotors.com>)

DASHBOARD AND FEATURES

Force/master Reset System



If your infotainment system touch screen becomes unresponsive or shows some unusual behavior, then you can restart it to potentially resolve the issue. Follow some basic steps given below and you can restart the system.

To restart the Infotainment System:

1. Park the vehicle.
2. Hold the Steering wheel Mute button (long press)  for more than 10 secs and then release the button as soon as the display goes blank.

3. The step above will trigger the infotainment system restart procedure. Wait until the system restarts.
4. When you hold the Steering wheel Mute button  for more than 15 sec, system aborts restart process and display turns ON.

NOTE

- *It is preferable to do one Ignition OFF to ON cycle after Master/Force reset to synchronize vehicle settings with the TATA Infotainment System.*
- *If the reboot does not work or Master/Force resets are required on a weekly or daily basis, vehicle shall be taken to dealership. There, the dealer can update your firmware or inspect the system for hardware problem.*
- *Force/Master reset keeps are the stored data, such as call history, text message information, and previously paired phones as it is.*

USB PORT (if equipped)

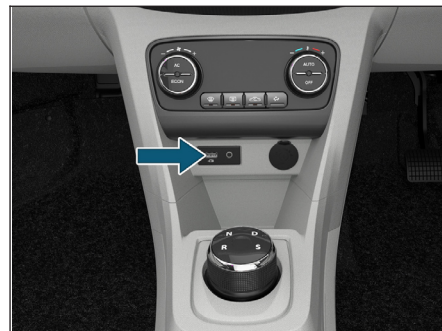

Connect your pen drives to this socket for playing music tracks through the vehicle's music system.

DASHBOARD AND FEATURES

POWER SOCKET



Power Socket Front

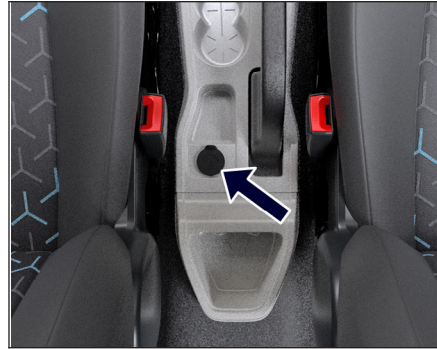

Power Socket Rear (if equipped)

The power socket will work when the ignition switch is in the “ACC” or “ON” position. This socket can be used to provide 12V (10A) power for electrical accessories.

NOTE

- *Use of unapproved electrical accessories can cause damage to your vehicle’s electrical system.*
- *Make sure that any electrical accessories you use are designed to plug into this type of socket and rating.*

ANTENNA

Option I

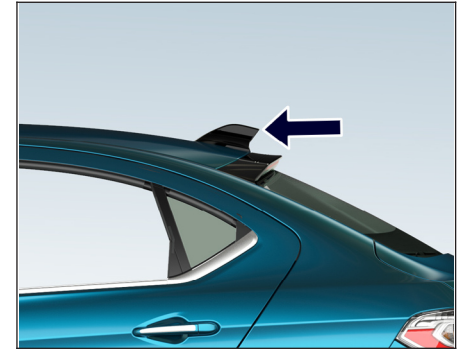

Shark FIN antenna is provided on the roof at rear end.

DASHBOARD AND FEATURES

Option II

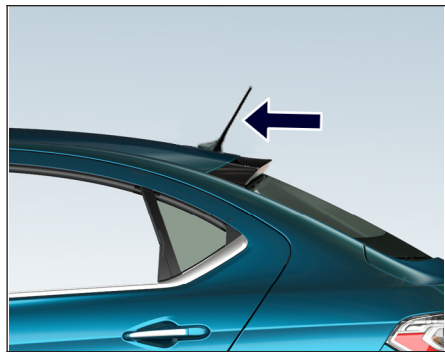

Antenna is located on the roof. Turn the antenna anticlockwise to remove it from the vehicle, if required.

ROOF GRAB HANDLE

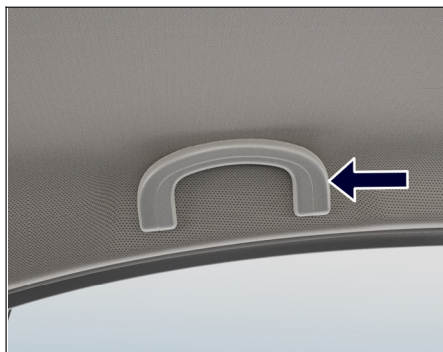

Grab handles are installed on the roof for all seats except for the driver's seat. These help the passengers to position themselves comfortably during the journey.

TAG HOLDER

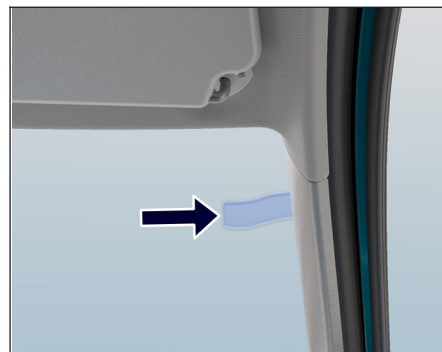

Tag holder is provided near the front windshield for ease of displaying toll, parking tickets, ID's, passes, labels etc.

HIGH MOUNTED STOP LAMP

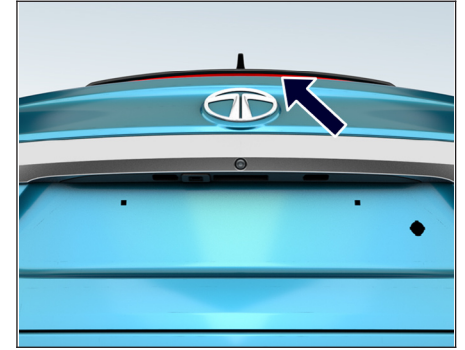

ROOF LAMP

Interior roof lighting lamp is provided on the roof within built switch.

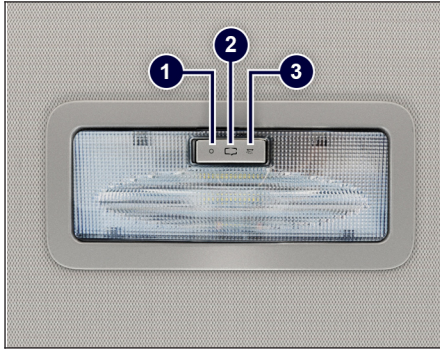

The switch has three positions:

ON

The lamp will turn 'ON' as long as the switch is in this position.



DOOR

In this position the lamp turns to 'ON' when either of the doors are opened. When



the last door is closed, the lamp will turn 'OFF' with dimming.

This helps settling in the seat and inserting the key in the ignition switch. When the key is turned to the 'IGN' position, the lamp goes 'OFF' immediately.

OFF

In this position, the lamp will remain 'OFF'.



DASHBOARD AND FEATURES

HEAD LAMP

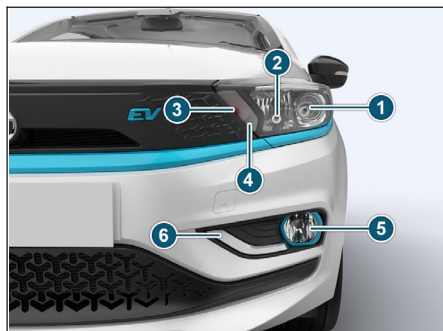

Head lamp consist of:

1. Low beam
2. High beam
3. Indicator lamp
4. Position lamp
5. Front fog lamp (if equipped)
6. DRL (if equipped)

TAIL LAMP

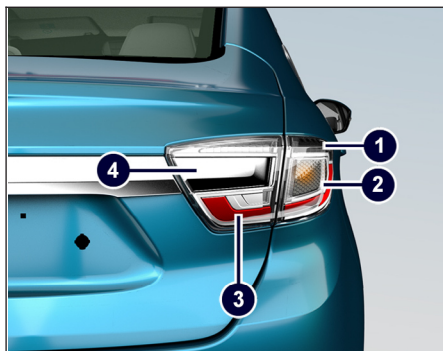

Tail lamp consist of:

1. Reverse lamp (on LH lamp only)
2. Stop / Position lamp
3. Turn indicator
4. Parking lamp

CONNECTED VEHICLE PROGRAM (CVP)

Car is equipped with Connected Vehicle which offers a host of features to the users through the "Connected Car" Mobile Application (APP). The Vehicle is equipped with an Electronic Control unit which monitors & records the data from various vehicle systems like Traction Motor, Battery & other electrical systems. This data is then processed & used for providing the connected Car features.

The Connected Car module records the following information:

Vehicle Telematics

This includes the periodic transmission of data from other vehicle ECUs & Electronic systems like EV Controller, Battery Controller, ABS etc. and also the geographical location of the vehicle.

DASHBOARD AND FEATURES

iINDIRECT TIRE PRESSURE MONITORING SYSTEM (if equipped)



Audible warning for 4 second will be given to alert the user, if

- Tyre Pressure is low
- Tyre Pressure is high
- Tyre temperature is high
- Tyre air pressure leakage

Also Audible warning for 10 second will be given to alert the user, if

- iTPMS system has fault
- iTPMS Sensor fault or missing

Vehicle driving behavior

This includes the location, speed, acceleration, trip details, charging etc.

Event based recording

This includes data generated during specific events like vehicle collision, intrusion, unauthorized entry etc.

The Data collected through Connected Car module is used by TATA PASSENGER ELECTRIC MOBILITY LTD. for various purposes, including, but not limited to,

Providing Connected Car features through Mobile APP.

- Evaluation of Vehicle performance.
- Research & improvement of current & future vehicle designs.
- Troubleshooting & diagnostics of the vehicle.

TATA MOTORS does not disclose the data recorded from your vehicle to any third party except:

- After obtaining a written consent from the Car Owner.
- Upon request from Law enforcing agencies and regulatory bodies.
- Used for research purpose without the Personal Verifiable information (anonymized).
- Used as defence of TATA MOTORS in a Law-suit.

STORAGE COMPARTMENT

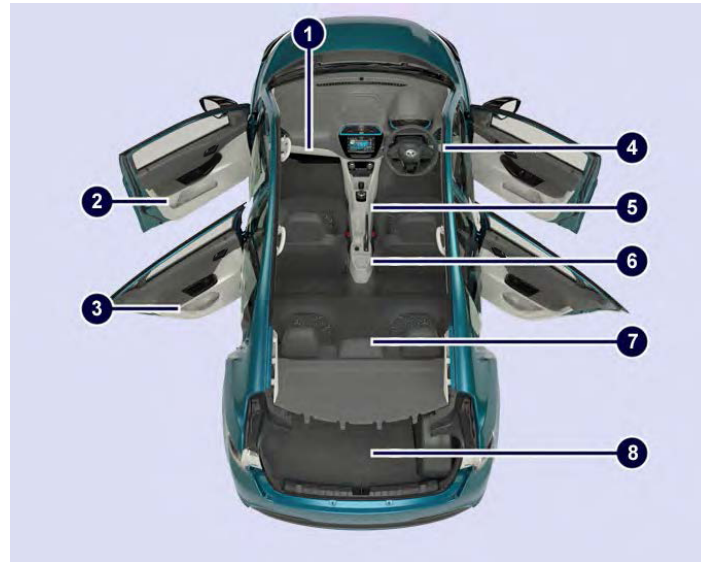

1. Glove box
2. Utility pockets on front door
3. Utility pockets on rear door
4. Driver side pocket
5. Center console
6. Stowage for rear passenger
7. Foldable arm rest
8. Tailgate compartment

STOWAGE AREAS

Glove Box



Opening and Closing

To open - Press the knob and open the glove box flap.

To close - Lift glove box flap upward until it engages.

NOTE

Make sure that glove box flap is closed while driving.

Stowage Details



Following items can be stowed in glove box.

1. Vent - Chiller glove box (If applicable)
2. Laptop holder
3. Pen / Visiting card holder

Cooling Facility (if equipped)

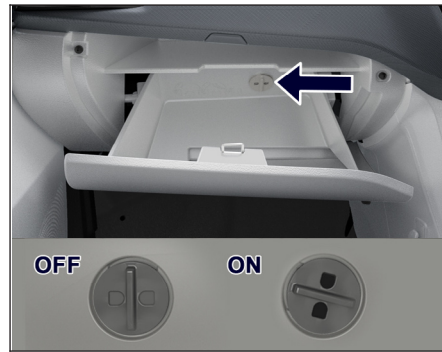

On selected models glove box is provided with a cooling facility. It cools the glove box only when the front A/C is ON. Shut OFF the vent by rotating the knob, whenever cooling is not required.

Driver Side Coin Box

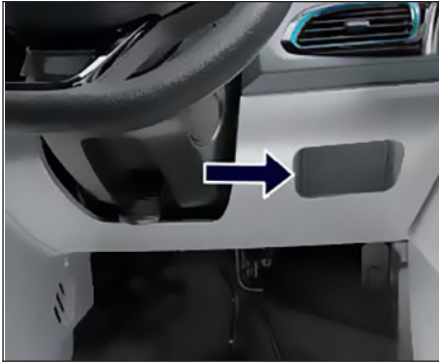

Stowage is provided on RH side of steering wheel for Coin, mobile and wallet.

Utility Pockets on Front Doors

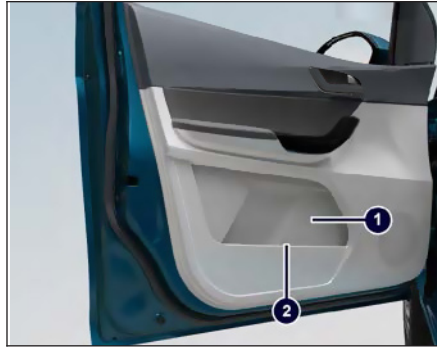

Utility pockets are provided on front doors and it can be used to keep following items.

1. Suitable water bottle
2. Magazine / paper / books

Utility Pockets on Rear Doors

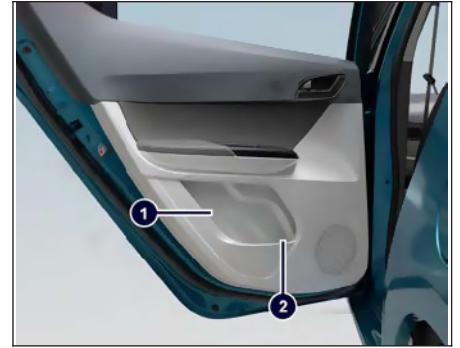

Utility pockets are available on rear doors and it can be used to keep following items.

1. Suitable water bottle
2. Magazine / paper / books

STORAGE AREAS

Center Console



1. Storage compartment

Storage compartment provided for keeping cell phones, iPod's, chargers etc.

2. Cup Holder

3. Bottle holder

4. Coin storage

Foldable Arm Rest



A foldable arm rest has been provided in the rear seat. It also has two cup holders, which can be accessed by opening the cover. When not required, fold the armrest back into the seat.

i NOTE

- Remove all items and cups before folding the cup holders.
- Use cups, containers, bottles of right size and which have lids.

Storage for Rear Passenger (if equipped)



Storage for the rear passenger is available on rear side of floor console between the front passenger seats. It can be used to keep phone and small items.

i NOTE

Applicable for models where rear vents is not provided.

Tail Gate Compartment

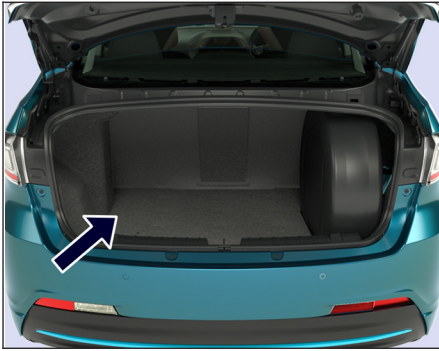

Store the luggage in tailgate compartment.

WARNING

- Distribute the items of luggage as evenly as possible.
- Do not place anything on luggage cover as it could obstruct driver's rear view. Also in case of an accident or sudden braking, it could cause an injury to occupants.
- Do not allow occupants to travel in the luggage compartment.

- Position heavy loads towards rear seat and as low down in the trunk as possible.

CARD HOLDER (if equipped)



A pocket is provided on the back of the driver side sun visor to keep cards, papers, etc.

STORAGE AREAS

HOOKS (if equipped)

Collapsible Hook



Collapsible hook is provided for hanging small carry bags etc.

i NOTE

Do not use these hooks for securing luggage like using nets etc. in the boot.

AIR DISTRIBUTION

The HVAC is operational when car is running and blower is 'ON'. The Climate control regulates the temperature in the car interior and filters dust particles. You can manually set the desired temperature.

The air is distributed through the vents in the passenger compartment as shown below:



i NOTE

If your car battery is discharged below 10%, your vehicle AC & heater will be automatically turned OFF, which is usual.

CLIMATE CONTROL

AIR VENTS

Air vents are available on the dashboard. The direction of air flow can be adjusted using sliders on the respective vents.



Centre Air Vents (Front)



Side Air Vents (Front)

i NOTE

The AC can be switched 'ON' only if the blower is 'ON' and motor is running.

When desired temperature is achieved AC trips 'OFF' automatically.

i NOTE

- *Water may drip from the under-side of the vehicle when it is in cooling mode. Traces of water on the ground are normal and are not a sign of leakage or malfunction.*
- *Ventilate the vehicle for a brief period during warm weather. This will speed up the cooling process and the desired vehicle interior temperature will be reached quickly.*
- *Do not cover the air vents or air intake grilles in the vehicle interior.*
- *If the AC is not used for a long period, such as during winter, it may not give the best performance when you start using it again. Operate the AC at least once a month to main*

tain optimum performance.

- *To get faster heating, it is recommended to set 4- 5°C higher set temperature than ambient temperature.*
- *While starting the vehicle after long duration (more than 15 days), follow the procedure for better AC performance.*
 - *Start the vehicle.*
 - *Switch the AC on and run it for 2~3 minutes. This circulates the refrigerant and oil to lubricate the internal parts of AC system.*

FULLY AUTOMATIC TEMPERATURE CONTROL (FATC)

General Description

FATC system controls the in-cabin temperature of the vehicle automatically and provides maximum passenger convenience regardless of outside weather conditions.

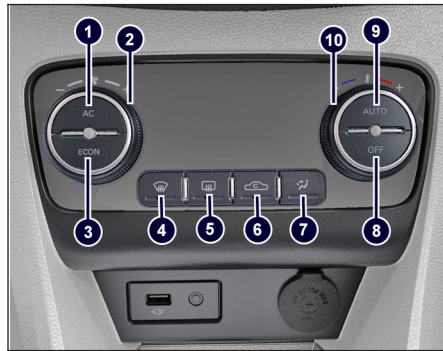

1. AC compressor ON / OFF button
2. Blower speed control knob
3. ECON
4. Maximum Defrost button
5. Rear window demister button

6. Fresh Air / Recirculation button
7. Air Distribution (mode) button
8. OFF button
9. Auto ON selection button
10. Temperature control knob

Display Unit



FATC display is shown on main display screen.

FATC functions can be controlled using both the FATC control panel and the touch screen display.

Whenever the user taps the FATC drawer, it expands & displays different climate control setting options like Temperature, blower speed etc. and so on used for

managing the climate control.

Also, when the display is not in climate mode then climate information will be displayed on the all-time display provide on top left corner.

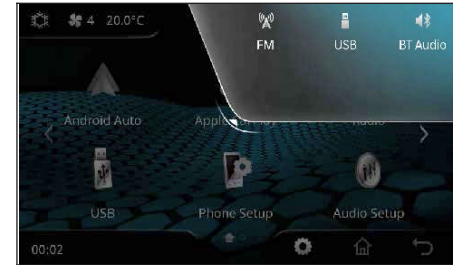

CLIMATE CONTROL

FATC Controls

AC ON / OFF Button



Press the AC compressor ON/OFF button to turn the air conditioning ON or OFF. The AC icon shall be activated on the display when the AC is ON.

Blower Speed Control Button



Rotate the knob clockwise to increase & anti-clockwise to decrease the blower speed.

ECON



During ECON AC operation, the system automatically cuts off compressor at a higher temperature than normal AC. The operation can be used during mild weather conditions for battery saving.

Comfort level may be compromised during this operation. By pressing ECON button text will be displayed on display.

Max Defrost Button

- This button directs the main airflow towards windscreen for faster defrosting. (It also overrides all modes).
- When you turn off the button, the system returns to its previous settings.



i NOTE

For your safety make sure you have a clear view through all the windows before driving.

Rear Window Demister Button

This button turns the rear window demister ON or OFF. The system will be deactivated after 15 min of continuous operation.



Fresh Air / Recirculation Button

- When the recirculation button is switched 'ON', air from the vehicle's interior is sent throughout the system.
- When the recirculation button is switched 'OFF', air is brought in from outside of the vehicle (fresh mode). Whenever discomfort is felt, switch to fresh air mode.



i NOTE

The outside air intakes for the climate control systems are at the base of wind





screen. Keep this area clear from leaves and other debris.

The system should be used with recirculation air mode for faster heat up and cool down, however keeping the system in recirculation mode, particularly with AC OFF, can cause the windows fog up.

Air Distribution (mode) Button

In AUTO mode, the FATC system will regulate the mode automatically. However, user override is possible with the use of MODE button to select the desired airflow mode.

Each time you press the MODE button, the display shows the mode selected.

	Directs air through the center and side air vents
	Directs air through the center, side and foot well vents
	Directs air through the foot air vents
	Directs air through the defroster & foot vents



Directs air through the defroster vents

“OFF” Button



Press the OFF button to switch OFF The system. OFF will be displayed on the infotainment screen.

Auto ON Selection Button



To put the automatic climate control in fully automatic mode:

1. Press the 'AUTO' button.
2. Set the desired temperature by turning temperature control knob. The display will show all the functions during 'AUTO' mode.
3. The system automatically selects the proper mix of cooled and / or heated air that will, as quickly as possible, raise or lower the interior temperature to your preference.
4. When you set the temperature to its lower limit (Lo) or its upper limit (Hi), the system runs at full cooling or heating only. It does not regulate the interior temperature.

CLIMATE CONTROL

NOTE

In 'AUTO' mode, the FATC system will regulate the blower speed automatically.

Semi-automatic Operation

You can manually select various functions of the climate control system when it is in fully automatic mode. All other features remain automatically controlled. Making any manual selection causes the word 'AUTO' in the display to go OFF and overridden setting is displayed. System will remain in semiautomatic mode till 'AUTO' is repressed.

Temperature Control Knob

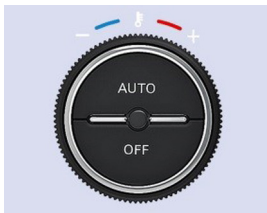

Turning the temperature control knob

clockwise increases the temperature of the air. The desired temperature will be increased by steps of 0.5°C. User can select temperature range from 18°C to 30°C. Whereas the anticlockwise direction decreases the temperature.

FATC Sensors (if equipped)

FATC system is fitted with three sensors.

Rain/light Sensor (if equipped)



The integrated rain and light sensor is mounted on front windshield glass to sense rain and light.

As per the input from sensor, the wipe and

light functions will work automatically.

Solar Sensor (if equipped)

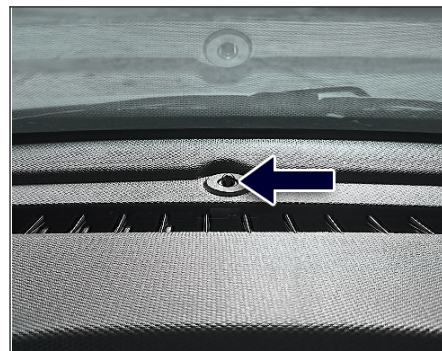

A solar sensor on the top of the dashboard.

In-car Sensor

In-car sensor on HVAC control panel.

Outside Ambient Temperature (OAT)

Outside Ambient Temperature sensor located under the front bumper grill.

NOTE

- Do not cover or spill any liquid on sensors.
- Do not cover sensor, this may cause the sensor to malfunction. This may lead to FATC not functioning to desired level.

Remote Ac Mode

AC can be controlled and temperature can be set remotely through mobile app.

For more information please refer telematics section.

NOTE

To control the battery temperature of the high voltage battery the air conditioner is used to cool down the battery and may switch on automatically without request from control panel which may generate noise from operation of the air conditioner compressor and cooling fan.

Also air conditioner's performance may be reduced during summer due to operation of the cooling system for the high voltage battery.

CAUTION

- It is important that the correct type and amount of oil and refrigerant used, otherwise damage to the vehicle and injury may occur. To prevent damage, the air conditioning system in your vehicle should only be serviced by trained and certified technician.
- We recommend that you contact authorized TATA EV dealer for more details

Quick Cooling















If your vehicle is parked under the sun, you can cool it down fast by following the steps given below:

1. Start the vehicle.
2. Turn the A/C on and make sure the temperature control is set to the lowest. In case of FATC set temperature to 'Low' mode.
3. Slightly open the windows and direct the vents towards the face.

CLIMATE CONTROL

4. When the interior has cooled down to a comfortable level, close the windows and set the required temperature, with recirculation ON.

Functions and Settings

Functions	Control Knob Position				Button Position			
								
Normal Heating	Desired Speed	Desired Temp	OFF	OFF	OFF	OFF	OFF	
Quick Heating	Max. speed	To the extreme right	OFF	OFF	OFF	OFF	OFF	
Normal Cooling	Desired speed	Desired Temp	ON	Optional	OFF	OFF	ON	
Quick Cooling	Max speed	To the extreme left	ON	Optional	OFF	OFF	ON	
Demisting Rear Wind-screen	Desired speed	To the right up to the desired Temperature	As desired	As desired	As desired	ON	As desired	As desired
Defrosting Front wind-screen	Max speed	To the right up to the desired Temperature	OFF	OFF	ON	OFF	OFF	
Demisting front wind-screen	Max speed	To the right up to the desired Temperature	ON	OFF	ON	OFF	OFF	

CLIMATE CONTROL

NOTE

For refrigerant specification watch sticker mention under bonnet.

PRE DRIVING CHECKS

Make Sure That

- Windshield, windows, mirrors, lights, and reflectors are clean and unobstructed.
- Tool kit, jack & handle, warning triangle, owner's manual, first aid kit and vehicle documents are available and stored at their locations.

WARNING

- Never put any mat on top of the floor carpet near pedal region.
- TATA MOTORS does not recommend use of any floor mats below driver foot, from occupant safety point of view. If floor mats are used by end user, for different reasons, they need to be secured in place with the provided floor carpet clips. This is recommended, as in normal driving conditions, floor mats may slip forward and interfere with pedals.
- All doors, motor bonnet and tail gate are securely closed and latched.

- All of your passengers are properly restrained. All occupants travelling should always wear seat belts or suitable CRS as applicable.
- Objects, luggage or loads are secured properly against slipping or tipping.
- Rear seat is securely latched.
- Sufficient range for the trip.
- Wheels are in correct alignment.
- Tyres have the recommended inflation pressures.
- To lighten your load by removing any unnecessary cargo.
- Windows are fully raised.
- Any mounted parts that may increase air resistance.

Daily Check

- Tyres - for abnormal wear, cracks or damage and embedded foreign material such as nails, stones, etc.
- Traces of fluid and oil below vehicle.

NOTE

Water dripping from the air conditioning system after use is normal.

- All lamps, wipers, wiper blades and horn for proper operation.
- All switches, gauges and tell tales are working properly.

Adjust

- Seats, head restraints (if equipped) and steering wheel position.
- All the mirrors properly adjusted.

Weekly Check

- Coolant level
- Brake fluid level
- Windshield washer fluid level

NOTE

Tyre pressure to be measured at cold condition.

Examine tyre pressure and condition after every 15 days including spare wheel.

STARTING AND DRIVING

TIPS TO GET MAXIMUM RANGE WHILE DRIVING

- If safe to do so, modulate the accelerator pedal instead of using the brake pedal when gradually slowing down. Whenever the vehicle is moving and you are not pressing the accelerator pedal, regenerative braking slows down the vehicle and feeds surplus energy back to the HV battery.
- Limit the use of feature such as heating, and air conditioning. If you operate the air conditioner/heater for long duration, it will use too much electricity from HV battery.
- Turn OFF the heater and air conditioner if you do not need them.
- Press and hold the accelerator pedal to maintain speed and drive economically.
- Gradually press and release the accelerator pedal when accelerating or decelerating.
- Do not use unnecessary electrical components while driving.

- Drive in ECO mode. It helps reduce power consumption by reducing acceleration when compared to the same accelerator pedal position in the D (Drive) position.
- Drive at a constant speed. Maintain cruising speeds with constant accelerator positions as much as possible.
- Accelerate slowly and smoothly. Gently press and release the accelerator pedal for acceleration and deceleration.
- Vehicle range may be substantially reduced in extremely cold conditions (for example, 0°C).
- Release the accelerator pedal to slow down and do not apply the brakes when traffic and road conditions allow.
- Do not load unnecessary items in the vehicle trunk.
- Do not mount parts on the exterior of the car as it might increase drag.
- Always maintain specified tyre pressures.

Acceleration, Braking And Coasting

Acceleration: This vehicle has a single speed automated gearbox. In accelerating mode, the torque supplied by the motor via the gearbox to the front wheels is linear in nature.

Braking and Coasting

- During braking, both the conventional brakes and regenerative braking contribute towards the braking effort.
- However, during coasting (when the accelerator pedal is released and no brakes are applied), only regenerative braking takes place.

Regenerative Braking

- This vehicle is equipped with a regenerative brake system. The primary purpose of the regenerative brake system is to provide some power to help recharge the High voltage battery and extend driving range.
- The electric motor when decelerating and braking transforms kinetic energy to electrical energy in order to charge the high voltage battery. (Torque is ap-

plied in the opposite direction when decelerating to generate braking force and electricity).

- A secondary benefit is an effect similar to “engine braking” seen in IC engine cars. Here, it depends on HV battery condition.
 - While driving, when the accelerator is released, the regenerative brake system provides some deceleration and generates power for the high voltage battery.
 - Power is also generated when the brake pedal is applied. When you brake and take your foot off the accelerator pedal, more regenerative brake is applied than in the drive mode.
 - However, during high-speed driving you may feel that regenerative brake provides less deceleration than the motor braking in an regular ICE engine vehicle.
 - Less deceleration is provided by the regenerative brake system when the High voltage battery is fully charged. Regenerative brake is automatically
- reduced when the high voltage battery is fully charged to prevent it from overcharging.
 - Regenerative brake is also automatically reduced when the battery temperature is high/low to prevent battery damage.
 - The brake pedal should be used to slow or stop the vehicle depending on traffic or road conditions. The vehicle brakes are not affected by regenerative brake system operation.

STARTING AND DRIVING

LIMP HOME CONDITION of EV

In situations when certain conditions in the vehicle are not met or when some fault arises in the vehicle, the vehicle control unit intervenes and puts the vehicle into Limp Home Mode. The Tigor.ev will give reduced performance in these situations. These limp home interventions are defined on two levels which are provided in the table.

NOTE



There will be a single audio chime whenever the vehicle goes into Limp Home Intervention along with the IPC message.

Sports mode cannot be selected if the vehicle SoC is below 25% or the vehicle is in limp home mode. If the vehicle is already in sports mode, it will automatically switch to drive mode. A message 'Gear Shift not allowed' will be displayed with an audio warning.

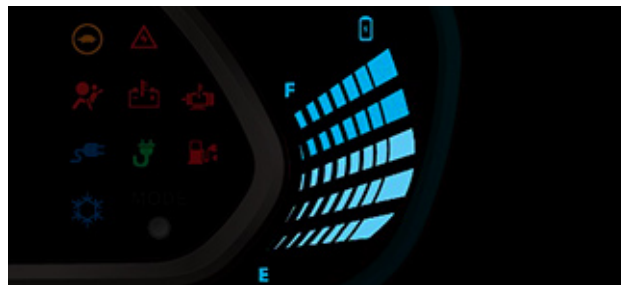
State of charge (SoC) gauge for high voltage battery



Limp Home Mode Telltale Warnings

Telltale Indicator	Condition	Description
	Blinking	HV Critical Fault Contact TATA MOTORS EV Service Station.
	Continuously ON	HV Critical Fault Mobility is not allowed Contact TATA MOTORS EV Service Station.
	Continuously ON	Vehicle has entered in Limp Home mode

Limp Home Strategy

Level 0 Intervention					
Zone	IPC message and state	Max speed	Acceleration	Grade ability	Cabin cooling
SoC <=25%	If the vehicle is in Sport mode, it will automatically shift to Drive mode which will be shown on cluster	No change	No change	29%	No change
SoC <=10%	Then SoC Gauge 1 st Bar ON with single chime and low charge, Limp Home Tell-tale will be ON & “RECHARGE” will display	50 kmph	Reduced	18%	No cooling
SoC <=5%	SoC Gauge 1st Bar will Blink along with Low Charger tell-tale with continuous chime	50 kmph	Reduced	18%	No cooling

STARTING AND DRIVING

Driving on Snow or Ice

WARNING

Wet ice (0°C and freezing rain), snow or ice can be slick and very hard to drive on. The vehicle will have much less traction or “grip” under these conditions. Try to avoid driving on wet ice until the road is salted or sanded.

- Whatever the conditions, drive with caution. *Accelerate* and slow down with care. If accelerating too fast, the drive wheels will lose even more traction.
- *Allow* more stopping distance under these conditions. Braking should be started sooner than on dry pavement.
- Allow greater following distances on slippery roads.
- *Watch* for slippery spots (glare ice). These may appear on an otherwise clear road in shaded areas. If a patch of ice is seen ahead, brake before reaching it. Try not to brake while on the ice, and avoid any sud

den steering maneuvers.

- Do not use cruise control on slippery roads.
- Use high quality ethylene glycol coolant.
- Your vehicle is delivered with high quality ethylene glycol coolant in the cooling system. It is the only type of coolant that should be used because it helps prevent corrosion in the cooling system, lubricates the water pump and prevents freezing. Be sure to replace or replenish your coolant in accordance with the maintenance schedule.
- Before winter, have your coolant tested to assure that its freezing point is sufficient for the temperatures anticipated during the winter.

Check Battery and Cables

Winter puts additional burden on the battery system. Visually inspect the battery and cables as described.

Don't Let your Parking Brake Freeze

Under some conditions your parking brake can freeze in the engaged position. This is most likely to happen when there is an accumulation of snow or ice around or near the rear brakes or if the brakes are wet. If there is a risk the parking brake may freeze, apply it only temporarily to block the rear wheels so the vehicle cannot roll. Then release the parking brake.

Don't Let Ice and Snow Accumulate Underneath

Under some conditions, snow and ice can build up under the fenders and interfere with the steering. When driving in severe winter conditions where this may happen, you should periodically check underneath the vehicle to be sure the movement of the front wheels and the steering components are not obstructed.

Carry Emergency Equipment

Depending on the severity of the weather, you should carry appropriate emergency equipment. Some of the items you may want to carry include tow straps or chains, flashlight, emergency flares, sand, shovel, jumper cables, window scraper, gloves, ground cloth, coveralls, blanket, etc.

We do not recommend using this vehicle for trailer towing.

BEFORE YOU START EV

- Make sure that the area around the vehicle is clear.
- Do a check of the fluid levels - coolant, brake fluid, and windshield washer fluid as frequently as possible.
- Make sure that all windows and lights are clean.
- Examine the tyres for their appearance, inflation pressure and condition.
- Make sure that all doors are closed.
- Position the seat and adjust the headrests.
- Adjust the inside and outside mirrors.
- Fasten seat belts and ask all passengers to do likewise.
- Do a check of the operation of the warning lights when the power switch is pushed to the ON position. For additional information, refer to “Warning lamps and audible reminders” in the “Dashboard and Features” section of this manual.

Procedure to Start EV

1. With the smart key sit in the driver's seat (if equipped)/Engage the key in the lock set.
2. Fasten the seat belt before you start the vehicle.
3. Make sure to engage the parking brake for your safety.
4. Turn off all electrical devices.
5. Make sure the accelerator and brake pedal have clearance with your right foot.
6. Make sure to press and hold the brake pedal.
7. The vehicle will get ON in 'N' mode only and it will be automatically selected.
8. Press and hold the brake while pressing the start/stop button or turning the key to on position.
9. When 'Ready' message appears, you can drive the vehicle. Else, you cannot drive the vehicle. Start the vehicle again.

STARTING AND DRIVING



10. Press and hold the brake pedal and rotate the gear knob to the desired position.
11. Release the parking brake and slowly release the brake pedal. See if the vehicle slowly moves forward, then press the accelerator pedal.

Procedure to Stop EV

1. Hold down the brake pedal while the vehicle is parked.
2. While pressing the brake pedal, shift the knob in N (Neutral).
3. While pressing the brake pedal, engage the parking brake.



4. Press the start/stop button or turn the key to OFF position to stop the vehicle.

i NOTE

The vehicle must always be put in 'N' when you stop the vehicle before en

gaging the park brake.

When the 'Ready' message is ON and if the gear knob is in a position other than N (Neutral), the driver can accidentally press the accelerator pedal, causing the vehicle to move unexpectedly.

Range of Your EV

The range of an electric vehicle is distance which the vehicle can travel with full depletion of battery, i.e. from 100% to 0% of battery charge. This depends on multiple factors such as vehicle speed, driving pattern, ambient temperature, road conditions, auxiliary loads, air conditioning etc.

For calculating the range of electric car, depletion should be more than 30%.

Tigor.ev is certified for range as per AIS040.

However, in real world condition, the factors mentioned above may deviate from the standard test conditions resulting in a different range value as compared to the certified value.

The estimated range in Instrument cluster

is computed based of predictive model that analyzes the current and historical drive segments of the vehicle. The model attaches suitable weightages to the energy consumption in these drive segments to arrive at a weighted energy consumption rate which when equated against the balance energy in the battery, gives the Distance To Empty value. The Model also takes into account the driving speeds, driving modes and the operating points of the vehicle.

The estimated Range is responsive to the changes in the energy consumption rate to ensure a realistic representation of the positive or negative effect the driving pattern has on the driving range.

Tips to Maximize Range

1. Regenerative Braking

Regenerative braking typically happens when Tigor.ev car decelerates with gear engaged. Deceleration happens when the accelerator pedal is disengaged. You may choose to apply brake for deceleration as well. While the regenerative power increases with brake application, regeneration is most efficient when the car is decelerated in coasting mode, i.e. when foot brake is not applied.

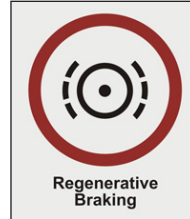

2. Interior Climate

Heating and Air conditioning system uses energy from the high voltage battery and this reduces range. For maximizing range during air-conditioning on driving, it is



recommended to set the air conditioning in Auto mode with Econ activated. Also the set temperature should be set between 24-26 deg C. Tigor.ev is equipped with Remote Air conditioning. You can remotely start Air Conditioning system. However, this also consumes energy from the high voltage battery and reduces the driving range.

3. Driving Speeds

At high speeds, greater than 80 kmph, high amount of energy is spent in propelling the vehicle and hence reduces range. Similarly, idling for long duration also reduces range significantly.

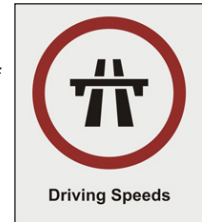

STARTING AND DRIVING

4. Driving Style

Driving behavior has a significant influence on the driving range of an electric vehicle. Frequent and heavy accelerations will have a detrimental impact on car's driv-

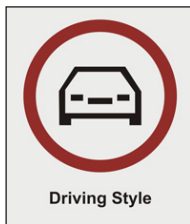

ing range whereas travelling at a steady pace, in between 40-80 km/hr will help an electric car to maximize range. Predictive driving with gradual acceleration reduces your reliance on hard braking. This helps conserve energy during acceleration and regenerate optimally during deceleration. However, brake should be applied as necessary to avoid hazards to occupants and surrounding.

5. Tyre Pressure

Maintaining specified Tyre pressure only ensures comfortable ride comfort but also maximizes range by minimizing rolling losses of the vehicle. It is advisable to reg-

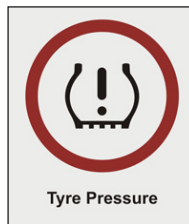

ularly monitor and maintain the tyre pressure within specified limits.

6. Unauthorized Electrical Accessories

Unauthorized aftermarket electrical accessories can potentially consume higher energy than factory fitted ones and may affect range directly. They can



also lead to functional complications and lower component life in the long run. It is recommended to fit only TATA Genuine Accessories at Authorized EV Service stations.

7. Vehicle Maintenance

Vehicle to be serviced regularly as per service schedule in authorized service stations. It helps in maximizing vehicle performance and component life.

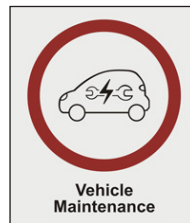

8. Battery Charging

For every 4 consecutive fast charges, 1 complete slow charge is recommended (<20% to 100% SoC) to ensure consistent performance and better health of the high voltage battery. This improves charge balancing during charging and deliver better driving range.

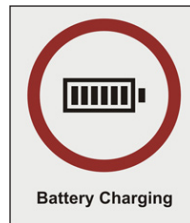

COLD WEATHER DRIVING

CAUTION

Do not store the vehicle in temperatures below -25°C for more than seven days. If the outside temperature is -25°C or less, the High voltage battery may freeze and it cannot be charged or provide power to run the vehicle. Move the vehicle to a warm location.

- Connect the charger to the vehicle and place the power switch in the ON position when parking the vehicle if temperatures may go below -20°C .
- Vehicle range may be substantially reduced in extremely cold conditions (for example under -20°C).
- Using the climate control system to heat the cabin when outside temperature is below 0°C uses more electricity and affects vehicle range more than when using the heater when the temperature is above 0°C .

Freeing a Frozen Door Lock

To prevent a door lock from freezing, apply

9. Dead Weight

Dead weight like bags, boxes etc. which is not required should be removed from the car. This lowers the energy required to propel the vehicle and improves driving range.

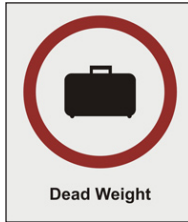

Different Modes in EV

There are three different modes that tell you the vehicle's energy consumption rate along with the charge / discharge status of the regenerative brakes. These are Power, ECO and Regeneration modes.

- **POWER:** It shows the energy consumption rate of the vehicle when driving uphill or accelerating. The more electric energy is used, the higher the gauge level.
- **ECO:** It shows the energy consumption rate during normal driving condition.
- **REGENERATION:** It shows level of energy saved using regenerative system when brakes are applied.

STARTING AND DRIVING

anti-icing agent through the key hole. Some examples of anti-icing agents are sodium chloride, potassium chloride, glycerol, and urea. If the lock becomes frozen, heat the key before inserting it into the key hole or use the remote keyless entry key fob. Handle the heated key with care to avoid burn injuries.

Antifreeze

In the winter when it is possible that the outside temperature will drop below 0°C, check the antifreeze to ensure proper winter protection. For additional information, refer to the Maintenance section of this manual.

12-volt Battery

If the 12-volt battery is not fully charged during extremely cold weather conditions, the 12-volt battery fluid may freeze and damage the 12-volt battery. To maintain maximum efficiency, the 12-volt battery should be checked regularly.

DRIVING TIPS

The battery life, vehicle range, brakes and tyre wear are mainly affected by below factors:

- Operating conditions of your vehicle
- Your personal driving style

Operating Conditions

- Avoid frequent start and stop as these reduce the battery charge.
- Always make sure that the tyre pressures are correct.
- Do not carry any unnecessary weight.
- Regularly service your vehicle and adhere to the recommended service maintenance schedule.

Personal Driving Style

- Do not press the accelerator pedal when starting the car.
- Always adapt your driving style to suit the prevailing road, weather conditions, and maintain a safe distance from the vehicle in front. Drive carefully.
- Avoid frequent, sudden acceleration

and braking. Keep an eye on the vehicle's range.

- Driving safety systems are merely aids designed to assist driving. You are responsible for the distance to the vehicle in front, for vehicle speed and anticipating braking in good time.

WARNING

You could lose control of your vehicle if you try to adjust the driver's seat, head restraint, mirror, steering wheel and fasten the seat belt while driving. There is a risk of an accident.

IMPORTANT TIPS

- Do not allow the vehicle to be discharged to 0% in storage.
 - It is recommended that the vehicle must be charged to a charge level in between 30% to 50% before leaving the vehicle for long time storage. It is recommended that the vehicle must be charged greater than 50% before leaving the vehicle for long resting period (>15 days). After this time period the vehicle must be charged to 100% using Slow Charging before use.
 - Do not direct high pressure washer fluid/ water jets (Pressure above 0.5 bar) at electrical devices and connector during washing. This is to prevent malfunction/failure of electrical system due to water ingress. No High pressure washing in Motor compartment, Under-floor battery pack and CCS Charging port.
 - Drive through calm water only and only if it is not deeper than 300mm and at this depth, the vehicle speed to be maintained at creep speed.
- If car gets completely or partially submerged in water, switch off the ignition, evacuate the car and call RSA (Roadside Assistance) at 18002098282 for assistance.
 - For optimum driving range use drive/eco mode and maintain the recommended tyre pressure.
 - As EV service requires certain skillsets and trained manpower, it is always recommended to get the car serviced or repaired at only TATA MOTORS authorized EV workshop.
 - Always check the SOC level before start of journey & ensure car is adequately charged. You may check the SOC level on the mobile app also.
 - Remote AC command not to be executed through mobile app while/during the charge initiation process.

EV Charging

- Do not use a damaged charging station, plug point or charging port. Using the charger with a worn or damaged port may result in unanticipated consequences.
- Ensure that the charging gun is always stored in a safe place. Do not expose it to rain or wet conditions. Avoid pouring or dripping water or other liquids over it.
- Charging should be done in Vehicle OFF state.
- Battery performance and durability can deteriorate if the fast charger is used constantly. Use of Fast Charging should be minimized in order to help prolong high voltage battery life.
- After a maximum of four continuous fast charging cycles, it is recommended to use Slow Charging and charge the car to 100% State of Charge for optimum performance of high voltage battery pack.
- If the charging gun is removed, rein-

STARTING AND DRIVING

sertion should be done after at least 10 seconds of removal of the charging gun.

- Once Slow/Fast charging is completed, 90 seconds of time gap is required before the vehicle can be started.
- Overcurrent and leakage current protections are given in the home charging box and charging gun. The RCBO (Residual Current Breaker with Over-Current) should always be in ON state during slow charging use-case and there should be no error (Red) LEDs on the charging gun. In case any tripping of RCBO is observed or error LEDs start blinking on the Charging gun, please contact TATA MOTORS Authorized EV Service Centre.
- Home charging box comes with a key and lock. It is recommended to lock the box during overnight charge or when the charging box is not in use to avoid misuse of the charging point.
- Do not disengage/play around with the Park brake/hand brake while vehicle in

fast charging condition.

SEAT ADJUSTMENTS

Front Seat Adjustments

Following seat adjustments can be carried out manually.



1. Backrest angle
2. Seat height (if equipped)
3. Seat forward / rearward adjustment lever

⚠ WARNING

Do not adjust the driver's seat while driving. Adjusting the seat while driving could cause the driver to lose control of the vehicle.

Seat Backrest Angle Adjustment

To change the seat back rest angle, lean forward slightly and pull up the lever (1). Adjust seat backrest until it reaches desired comfortable position. Make sure that lever returns to its original position and seat is securely latched.

i NOTE

Adjust the seat backrest until your arms are slightly angled when holding the steering wheel.

⚠ WARNING

Never travel in a moving vehicle with the seat backrest in an excessively reclined position as this can be dangerous. You could slide under the seat belt

in a collision.

Seat Height Adjustment (if equipped)

To raise the seat, pull and continue pumping the lever (2) in the upward direction until the seat is at the desired height.

To lower the seat, pump the lever downward until the seat is at desired height.

Seat Forward / Backward Adjustment

Lift lever (3) and slide the seat forwards or rearwards. Release lever and make sure that seat is securely latched.

i NOTE

Adjust the driver seat position in such a way that the driver will be able to operate the controls pedals comfortably.

Adjustable Head Restraint (if equipped)



Adjust the head restraint so that it is as close to the head as possible and the center of the head restraint supports the back of the head at eye level. This will reduce the risk for injury to the head and neck in the event of an accident or similar situation.

STARTING AND DRIVING

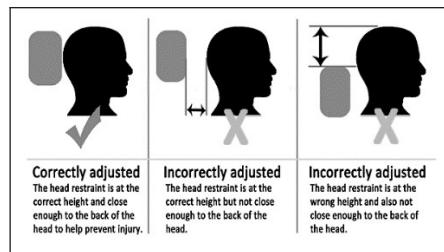

WARNING

Do not drive the vehicle without the seat head restraints. Head restraints are intended to help reduce injuries during an accident.

NOTE

Head restraint integrated with seats are not adjustable.

Occupant Detection System (ODS)

Use of aftermarket cover over the seats may impact the performance of ODS in front passenger seat.



REAR VIEW MIRRORS

Inside Rear View Mirror (IRVM)

To adjust the mirror move the mirror up, down or sideways manually to obtain the best rear view.

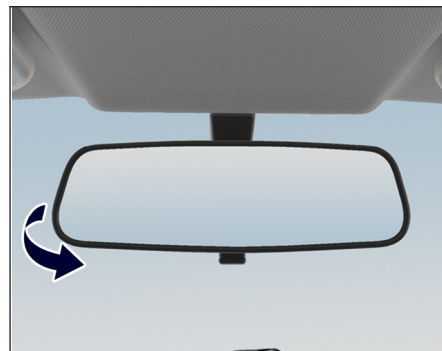

Outer Rear View Mirrors

You can adjust the outer rear view mirrors manually with the knob located on the driver's and front passenger's door panel. Adjust the outside rear view mirrors to desired position.

i NOTE

Objects visible in mirror are actually closer than they appear. Always make sure of the actual distance from the road users traveling be-hind by glancing over your shoulder.

Motorized Outer Rear View Mirrors (if equipped)

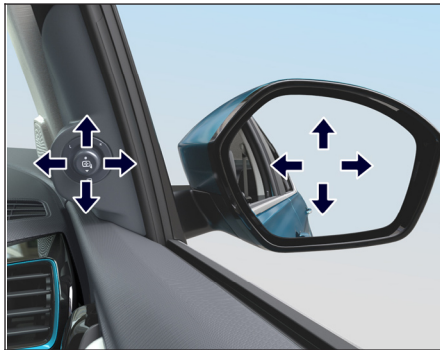

The switch to adjust the motorized mirrors is located on the driver's door. You can adjust the mirrors when the ignition switch is in the "ACC" or "ON" position.

To Adjust the Mirrors

1. Move the selector switch to the left (L) or right (R) to select the mirror you wish to adjust.
2. Press the outer part of the switch that corresponds to the direction in which you wish to move the mirror.

ORVM FOLDING (if equipped)

Option 1: Manual Folding

ORVMs can be folded or unfolded manually. This is applicable only for vehicles which are not equipped with motorized folding provision.

Option 2: Auto Folding by Smart Key



When you lock the vehicle, ORVMs will be folded automatically.

When you unlock the vehicle, ORVMs will be unfolded automatically.

In case to repeated usage, Mirror Fold-

STARTING AND DRIVING

ing/Un-folding will stop functioning and will be re-activated after delay of 2 min. During that period avoid repeated pressing of Switch.

Option 3: Auto Folding by Knob

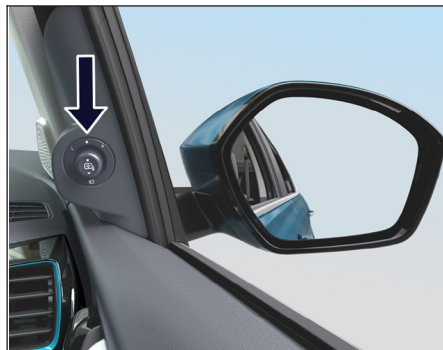

To fold / unfold the ORVMs, keep the Selector switch in center position (i.e. neither 'L' nor 'R, position) and then toggle down. This will operate when the ignition switch is in the "ACC" or "ON" position.

Option 4: Rear View Mirror with Joy-stick Knob

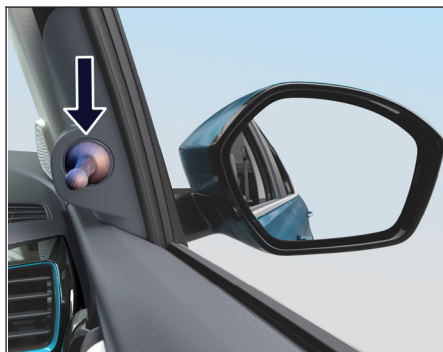

You can adjust the outer rear view mirror manually by joy stick knob located in the driver's and front passenger's door panel.

SUN VISORS



The sun visors can be pulled down to block glare coming through the windshield.

To Block Glare from Side Windows

Pull down the sun visor and release it from retainer. Swing the sun visor to the side.

Vanity Mirror

Vanity mirror is available on the back of the front passenger side sun visor.

STEERING WHEEL ADJUSTMENT

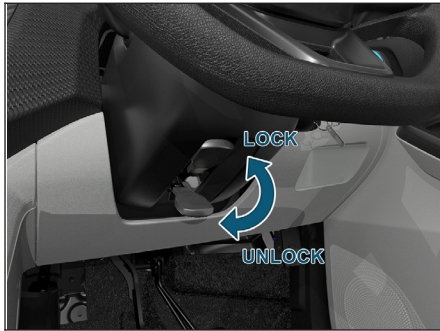

You can adjust the steering wheel position to suit your convenience.

The release lever is located under the steering column.

To Adjust the Steering Wheel

1. Adjust the seat to a comfortable position.
2. Push release lever completely down to unlock the steering column.
3. Adjust the steering wheel to the desired position.
4. Pull release lever up completely to lock

the steering column.

5. Make sure that steering wheel is correctly locked by checking up and down direction.

i NOTE

*When adjusting the steering wheel, make sure that:
You can operate control pedals without any obstacles.
You can see all the displays in the instrument cluster clearly.*

⚠ WARNING

Before starting off, make sure the steering wheel position is locked. Never unlock or adjust the steering wheel while the vehicle is in motion.

Braking

Your vehicle has disc brakes upfront and drum brakes at the rear. The distance needed to bring the vehicle to a halt increases with the speed of the vehicle. Start applying brake anticipating the distance and slow down gradually.

⚠ WARNING

- Do not use the brake pedal as a footrest.
- If you rest your foot on the brake pedal while driving, the braking system can overheat. This increases the stopping distance and can even cause the braking system to fail. There is a risk of an accident.
- Do not depress the brake pedal and the accelerator pedal at the same time.

If you have driven for a long time in heavy rain without braking, there may be a delayed reaction from the brakes when braking for the first time. This may also occur after the vehicle has been washed.

Brake performance may become poor and unpredictable if brakes are wet. After driving through water or washing the underside of the vehicle, test the brakes while driving at a slow speed to see if they have maintained their normal effectiveness. If the brakes are less effective than normal, dry them by repeatedly applying the

STARTING AND DRIVING

brakes while driving slowly until the brakes have regained their normal effectiveness.

Braking on Downhill Gradients

On long and steep gradients, you must reduce the load on the brakes by lifting your foot off the accelerator. This allows you to take advantage of regenerative braking and helps avoid overheating and excessive wear of the brakes.

STEERING LOCK CUM IGNITION SWITCH



The ignition switch has the following four positions:

LOCK - This is the normal parking position. Key from lock can be removed in this position only.

“LOCK” position prevents normal use of the steering wheel after the key is removed.

To release the steering lock, engage the key and turn it clockwise to one of the other positions.

ACC - Accessories such as the infotainment system can be operated, but the ve-

hicle remains ‘OFF’. Steering gets unlocked.

ON - This is the normal operating position. All electrical systems are ‘ON’.

START - Turn the key further clockwise to the START position, (spring loaded) to start the vehicle. As soon as the vehicle starts, release the ignition key, which returns to ON position. While cranking, all accessories will be momentarily ‘OFF’.

Illuminated Key Ring (if equipped)

When the vehicle is unlocked, the illuminated key ring glows up. This helps to locate ignition switch in the dark.

ELECTRICAL POWER ASSISTED STEERING (EPAS)

Your vehicle is equipped with electric power assisted steering system. The EPAS system assist you to steer the vehicle. If the motor is 'OFF' or if the EPAS system becomes inoperative, the vehicle still can be steered with more steering effort.

In EPAS system, the steering effort becomes heavier as the vehicle speed increases and becomes lighter as the vehicle speed decreases for better control of the vehicle at different vehicle speeds.

This EPAS system is equipped with the following assist features,

1. Speed sensitive assist control
2. Active return control

NOTE

The following symptoms may occur during normal vehicle operation:

- *The EPAS warning light does not illuminate.*
- *The steering effort can suddenly increase, if the operation of the EPAS system is stopped to prevent serious accidents when it detects malfunction of the EPAS system during self-diagnosis.*
- *Extreme continuous steering may increase the steering efforts. This occurs to prevent internal overheating and permanent damage to steering system.*
- *A 'click' sound may be heard from the EPAS relay after the ignition switch is turned ON or OFF position.*
- *Motor noise may be heard when the vehicle is at low driving speed.*
- *The steering wheel may not unlock normally in some cases when igni*

tion key turned 'ON' or motor start/stop button pressed. If this happens, turn the steering wheel to the right or left slightly to unlock the steering wheel while turning the ignition key or pressing motor start/stop button.

WARNING

If the EPAS system does not operate normally, the warning light  will light up on the instrument cluster. The steering wheel rotation may become difficult to control or operate, then take your vehicle to an authorized TATA EV dealer and have the EPAS system checked as soon as possible.

STARTING AND DRIVING

GEAR MODES



Neutral

Vehicle is in neutral gear position. This will be indicated 'N' in instrument cluster.

Drive

Vehicle moves forward and 'D' will be indicated in instrument cluster.

Sport

The acceleration is more when compared to 'Drive' mode as the throttle response is increased. It is indicated as 'S' in the instrument cluster.

WARNING

- Always make sure to keep the gear shift knob in the 'N' position when ignition is ON and vehicle is stationary.
- Do not shift the rotary knob in 'N' position, even momentarily, when the vehicle is in motion.

Reverse

Reverse gear can be engaged only when vehicle is stationary and brake pedal pressed. An audio signal indicates when reverse gear is engaged. 'R' will be indicated in instrument cluster.

STARTING AND DRIVING (PEPS)

Motor Passive Start / Stop



Start/Stop button is provided on the dashboard towards the left side of steering wheel.

Start / Stop Button

A Start/Stop button or Push to Start Button is a main component of Passive (Motor) Start and Stop system. It is used to control ACC, IGN outputs as well as to start and stop the motor.

i NOTE

- If Smart key is inside the vehicle and on pressing start stop switch, if start stop switch green LED blinks for 10 seconds then rotate steering wheel and simultaneously press start/stop button again.
- If smart key is inside the vehicle and on pressing start stop switch, if start/stop button green LED blinks more than 10 seconds, then contact authorized TATA MOTORS EV dealer.
- If ESCL (Electronic Column Steering Lock) is not unlocked properly, then vehicle doesn't go into ACC mode.

Backup Start

If smart key battery voltage is low or empty and vehicle is in OFF mode then to start the motor user needs to keep valid smart key near Immobilizer antenna (in centre console) then press start/stop button two times with interval of 2.5 seconds between

two presses after pressing the brake pedal.



Emergency Start

i NOTE

If ESCL (Electronic Column Steering Lock) is not unlocked properly, then Motor will not get cranked.

PEPS Features

Passive Entry

Entry in Vehicle through Driver Door:

- Customer reaches to driver door.

- Customer presses driver door handle switch along with valid Smart key within authentication range approx. 1.2 m.



UID (Smart Key)

Tailgate Opening of vehicle:

- Customer reaches to tailgate.
- Customer presses tailgate handle along with valid Smart key within authentication range of 1.2m.

STARTING AND DRIVING



Tailgate handle

i NOTE

Press the tail gate button on smart key and press the tail gate door handle switch within 30 seconds to open it.

Passive Exit

Exit from Vehicle through Driver Door

- Customer finishes driving and switches off the vehicle.
- Customer exits the vehicle and closes door.
- Customer presses driver door handle

switch along with valid Smart key within authentication range of 1.2m.

- Vehicle gets locked.



Parking Brake

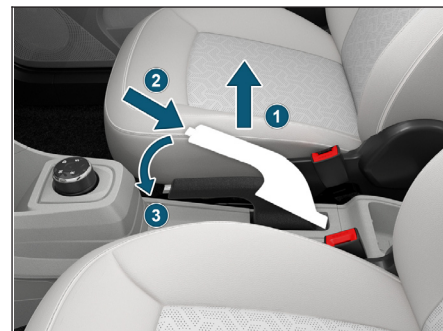

Parking brake released

To release it, pull the lever up slightly (1), press the release button (2) and push the lever down (3). Parking brakes tell-tale on the instrument cluster will turn 'OFF' when the lever is fully released.

i NOTE

Apply the parking brake properly before leaving the vehicle and release it before moving.

Mechanical parking brake acting only on the rear wheels is provided on the vehicle. To apply the parking brake, pull the lever up fully. The parking brakes tell-tale illuminates on the instrument cluster.

Vehicle Parking

- Park the vehicle in a safe place. Switch on the indicator signal before turning to park.
- Apply the parking brake.
- Ensure that all window glasses are closed and all lamps are turned 'OFF'.
- At night, put on the parking lights if required.
- Remove the key from the ignition switch and lock the vehicle.
- Block the wheel if parked on a slope.

NOTE

While parking on uphill or downhill gradients, place the gear lever in the 'N' position and engage parking brake.

WARNING

Never leave children unsupervised in the parked vehicle. They could also operate the vehicle's equipment. There is a risk of an accident and injury.

NOTE

Do not use parking brake for braking unless unavoidable circumstances like when service brake is not working properly. The braking distance is considerably longer and the wheels could lock. There is an increased danger of skidding and accidents.

STARTING AND DRIVING

REVERSE PARK ASSIST WITH SENSOR (if equipped)

Reverse Park Assist system is an electronic parking aid that will assist you to park your vehicle safely when in reverse gear mode. It provides audio and visual information through the vehicles infotainment system. The reverse park assist system can also be activated manually through infotainment screen.

Always look at surrounding before initiating reverse parking, for kids, pets and elderly people moving around the vehicle.

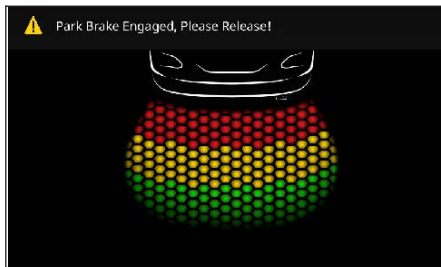

There are ultrasonic sensors placed on the rear bumper of the vehicle. Once the system is activated, the sensors will detect the

proximity of an obstacle from the bumper, and this information would be displayed on the vehicles infotainment system. In Low variants, only audio warning shall be given through a buzzer.

Approximate Distance From Bumper, In Cm	Visual Information	Audio Warning
25-40	All six zones are highlighted (red, yellow, green)	Continuous beep
41-80	Bottom four zones are highlighted (yellow and green)	Fast beep
81-120	Bottom two zones are highlighted (green)	Slow beep

In case of low end variants where Infotainment system is not available, audio buzzer will be played within first two seconds to indicate the proper functioning of the system when reverse park assist is activated. After these two seconds, normal functioning of the system will continue. If no audio buzzer is heard for first two seconds, it mean that RPAS system is faulty. Please take the vehicle to a TATA MOTORS Authorized EV Service Centre.

WARNING

0 to 25 cm obstacle detection performance is not guaranteed due to ultra-sonic sensor technology limitation.

Park Assist Indications

If Reverse park assist system malfunctions, the following fault messages will appear on the infotainment system.

Reasons for this fault may be:

1. Park Assist Controller / Body Control Module Failure
2. Sensor malfunction.

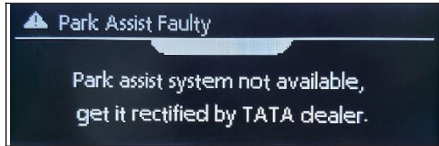

Reverse Park Assist Limitations

Reverse Park Assist system is not a collision avoiding system. It is solely the driver's responsibility to park the vehicle safely.

Reverse Park Assist feature works on ultra sound echo technology, due to which performance is not guaranteed in following scenarios:

- If the object has a sharp edge surface, where surface may divert echoes from sensor reception.
- If object is mesh fence made up of thin wires, where echoes can't be given by the surface.
- Fast moving objects passes in the sensor field of detection, where echoes are not processed by the system.
- If object is made/covered by foam or sponge or snow where ultrasonic sound signals are absorbed.
- Objects close to the rear bumper can go undetected by the Reverse Park Assist field of detection. Driver should use extreme caution while parking the

vehicle.

- If height of the bumper is changed due to alteration to the suspension or other causes
- If the sensor areas are extremely hot from direct sunlight or cold due to freezing weather.
- If sensors are covered by a hand, sticker, accessory, etc.
- If ultrasonic noise is present around Vehicle due to other vehicle sensors, horn, motor, air braking system (large vehicles), Exhaust Fans, Wireless transmitters or mobile phones
- If the vehicle speed exceeds 10 kmph, the system will not warn you even though objects are detected, error message 'Vehicle Speed is high, drive slowly!' will appear.
- Driving on uneven road surfaces e.g. Gravel, unpaved roads, Artificial Speed Breakers, or gradient.
- Poles of square/rectangular cross section might not be detected due to the ultrasonic technology limitation.

STARTING AND DRIVING

WARNING

Due to any reason, if the sensor gets misaligned or loses its intended fitment position, contact your dealer for re-fitment.

NOTE

Turning the ignition 'OFF' while the Park assist feature in running would disable the feature.

Reverse Park Assist System Preventive Maintenance

1. Regularly clean the Sensors/camera* (*if equipped) and keep them free from dust, ice, mud, water, chewing gum etc. for proper working of the system. Use a smooth cloth for cleaning.
2. Do not use water at high pressure for cleaning the sensor or camera.
3. Do not cover the Sensors/camera* (*if equipped) surface with any additional fitment. This will interrupt park assist performance.
4. Do not remove mud, snow on the sensors using stick or hard material. Use normal water and soft cloth.

General Warnings

1. In low light conditions, the screen may darken or image may appear faint.
2. If the tire sizes are changed, the position of the fixed guidelines displayed on the screen may change.
3. In case of damage of the rear portion of the vehicle, Reverse Park Assist sensors position may change which

causes wrong visual information on display. In case of damage make sure that Reverse Park Assist sensors are fitted properly at the intended location.

4. In case of uneven road conditions or uphill or downhill conditions, do not depend on Reverse Park Assist aid.
5. Do not apply any kind of force on the reverse park assist sensors.
6. Always use rear view mirrors along with Reverse Park Assist for confirming the safety of the rear and the surrounding conditions.

REAR VIEW CAMERA



Rear View Camera is a visual reverse guiding system. When reversing or parking, make sure that there are no persons, animals or objects in the area which you are reversing.

i NOTE

Turning the vehicle 'OFF' while the reverse park assist feature in running would disable the feature.



Display screen

Activation

Reverse Mode

This system will activate, if reverse gear is engaged, or reverse park assist button (if equipped) is pressed.

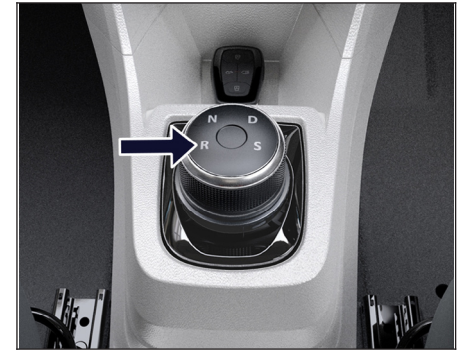

Deactivation

System will stop, if reverse gear is disengaged, or reverse park assist button (if equipped) is pressed.

STARTING AND DRIVING

Understanding Guidelines Indication



Green Line

You can safely reverse the vehicle, but be cautious if objects fall in this zone.

Yellow Line

You have to take utmost care if objects fall in this zone. However, the objects may not hit vehicle.

Red Line

Red line indicates that you have to stop reversing the vehicle. If you still go backwards, the car will hit the obstacle.

Do's and Don't

- Do not use camera when tailgate is open. If tailgate is open, visual in-for-

mation may not be the actual rear view of the vehicle & system will warn with message 'Tail Gate Open, Please close'.

- When the camera is operated under fluorescent lights, sodium light or mercury light etc., illuminated areas on the lens may appear to flicker in the display.
- Do not attach any advertisement or styling or any kind of stickers on top of camera. If this happens, camera cannot provide you the visual image and may damage camera.
- Do not add any accessory, which will obstruct camera field of view.

Cleaning Camera

1. Due to environmental reasons, dust, mud or fog may accumulate on the camera lens. So regularly clean the camera lens.
2. Use water to clean the camera lens. Do not use extreme cold or hot water. Rapid changes in temperature may brittle the camera lens. Do not apply High Pressure water for cleaning.
3. Wipe the camera lens with soft cloth. Do not use hard cloth or material to wipe the camera lens. This will cause scratches on the camera, and leads to deteriorated visual image on the display.
4. Do not apply organic solvent, car wax, window cleaner or glass coat to clean the camera. If this is applied, wipe it off as soon as possible.
5. Do not apply heavy force on lens, while cleaning.
6. Do not remove mud, snow on the camera lens using stick or hard material. Use normal water and soft cloth.

WARNING

- The camera uses fish eye lens. So the size of the objects or in the display may differ from the actual size and distances in low light conditions, the screen may darken or image may appear faint.
- If the tire sizes are changed, the position of the fixed guidelines displayed on the screen may change.
- During rainy conditions, image may get obscured. In such conditions, do not depend on camera view. The camera used in the vehicle, may not reproduce the same color of the real object.
- In case of damage of the rear portion of the vehicle, camera position may change. Which causes wrong visual information on display. In case of damage, make sure that, camera is fitted properly at the intended location.
- In case of uneven road conditions or uphill or downhill conditions, do not

depend on rear view camera park aid.

- Always use rear View mirrors along with Rear View Camera for confirming the safety of the rear and the surrounding conditions.
- Do not apply any kind of force on the camera.
- High humidity and variation in ambient temperature may result into condensation inside the camera lens, which may further result into degradation of camera video feed on the screen. It is recommended that not to rely on camera video feed for parking assistance in such scenario. This phenomenon is temporary and will be automatically recovered with reduction in humidity and less variation in ambient temperature.
- The area displayed by the rear view camera is limited. The camera does not display objects that are close to or below the bumper, underneath the vehicle, or objects out of the

camera's field of view. The area displayed on the screen may vary according to vehicle orientation or road conditions.

STARTING AND DRIVING

Rear View Camera System Precautions

Area displayed on screen

The rear view camera system displays an image of the view from the bumper of the rear area of the vehicle.

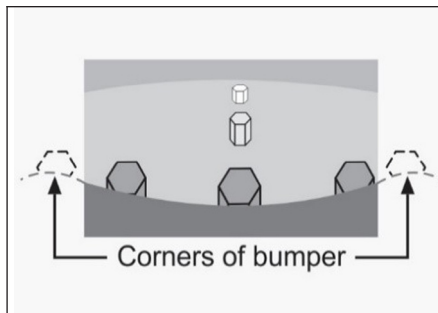
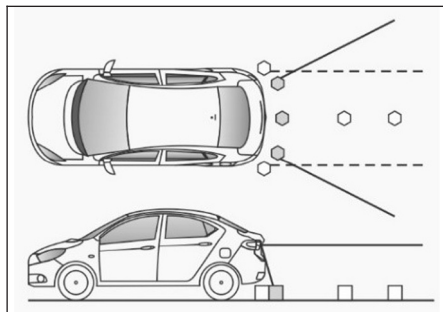

- The area displayed on the screen may vary according to vehicle orientation conditions.
- Objects, which are close to either corner of the bumper or under the bumper, cannot be seen on the screen.
- The camera uses a special lens. The distance of the image that appears on the screen differs from the actual distance. The camera may not display items that are located higher than the camera's field of view.

When the ground behind the vehicle slopes up sharply

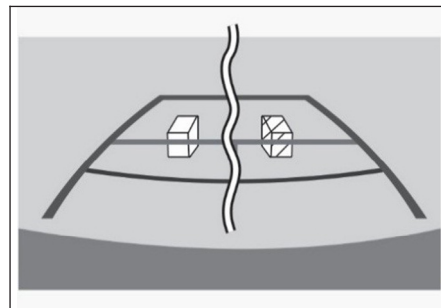
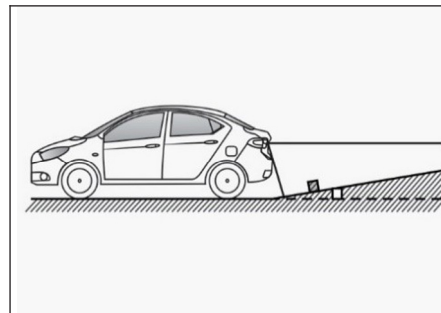

The distance guidelines will appear to be closer to the vehicle than the actual dis-

tance.

Because of this, objects will appear to be farther away than they actually are.

In the same way, there will be a margin of error between the guidelines and the actual distance/course on the road.

When the ground behind the vehicle slopes down sharply

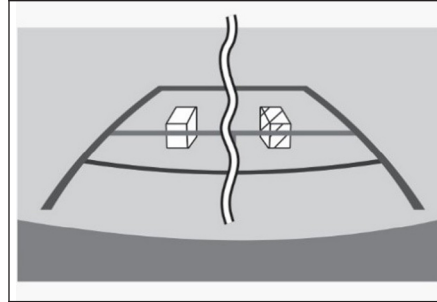
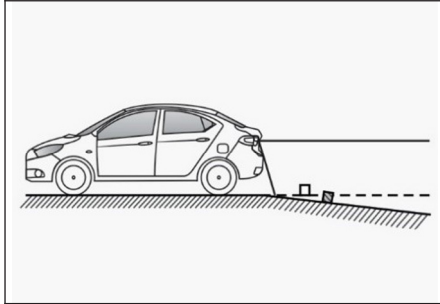

The distance guidelines will appear to be further from the vehicle than the actual distance.

Because of this, objects will appear to be closer than they actually are. In the same way, there will be a margin of error between the guidelines and the actual distance/course on the road.

When any part of the vehicle sags

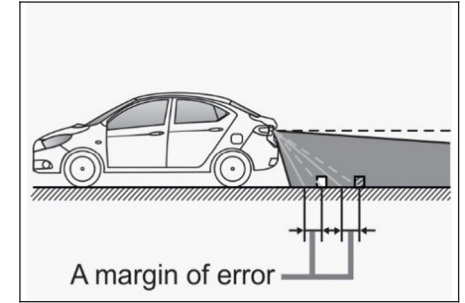

When any part of the vehicle sags due to the number of passengers or the distribution of the load, there is a margin of error between the fixed guide lines on the screen and the actual distance/course on the road.

STARTING AND DRIVING

When approaching three dimensional objects

The distance guidelines are displayed according to flat surfaced objects (such as the road). It is not possible to determine the position of three-dimensional objects (such as vehicles) using the distance guidelines. When approaching a three-dimensional object.

a. Distance guidelines

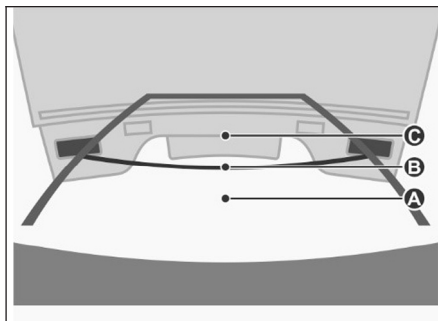
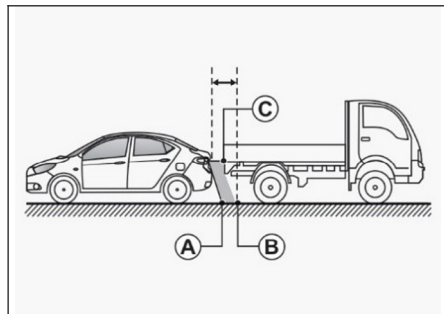

Visually check the surroundings and the area behind the vehicle. On the screen, it appears that a truck is parked at point B. However, in reality if you back up to point A, you will hit the truck. On the screen, it appears that A is closest and C is furthest away. However, in reality, the distance to A and C is the same, and B is further away from A and C.

b. Vehicle width guidelines

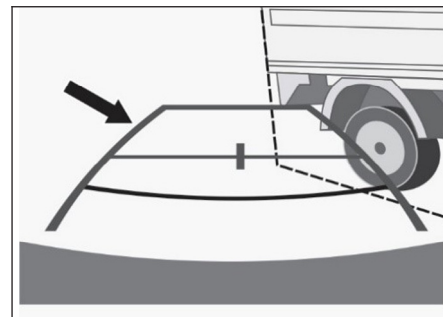
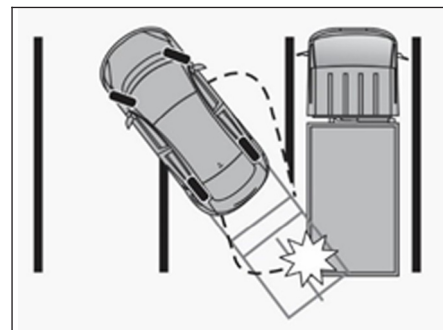

Visually check the surroundings and the area behind the vehicle. In the case shown

below, the truck appears to be outside of the vehicle width guidelines and the vehicle does not look as if it hits the truck. However, the rear body of the truck may actually cross over the vehicle width guidelines. In reality if you back up as guided by the vehicle width guidelines, the vehicle may hit the truck.

EMERGENCY AND BREAKDOWN ASSISTANCE

EMERGENCY EQUIPMENT

You should be familiar with the location of the emergency equipment provided in the vehicle and how to use it.

Do a check of this equipment periodically and make sure that they are in proper working condition and stowed at their locations.

First Aid Kit

The first aid kit is kept inside the glove box compartment.

The kit contains items that can be used in case of minor injuries only.

i NOTE

Examine contents of the first aid kit periodically and replenish consumed or expired items.

Tool Kit, Tow Hook, Jack and Spare Wheel

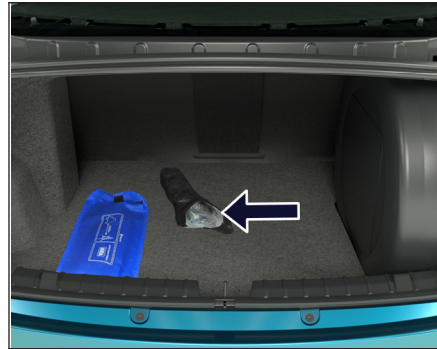

Tool kit & tow hook are kept inside luggage compartment near spare wheel.

i NOTE

The tool kit should be properly stored when not in use.

Jack Location



The jack is placed under the driver seat.

i NOTE

The jack should be used only to change wheels. It is important to read the instructions in this section before attempting to use the jack.

EMERGENCY AND BREAKDOWN ASSISTANCE

Advance Warning Triangle

An advance warning triangle is kept in the luggage compartment.

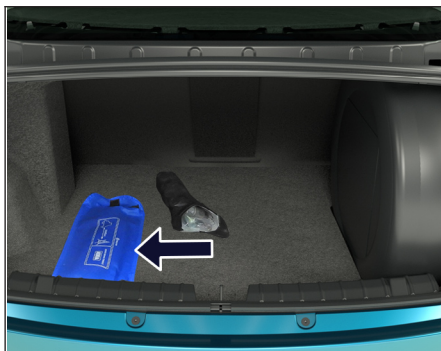

Use advance warning triangle to warn the approaching traffic in case of vehicle break-down or during emergency, where



your vehicle could become a potential traffic hazard.

When you press the hazard warning switch, all turn signal lamps will start to blink.

Keep the warning triangle at an approximate distance of 50-150m behind your vehicle in the same lane of traffic. The reflecting side of the triangle should face the oncoming traffic and it should be free from any obstacles.

Remove the advance warning triangle carefully from the bag and assemble. Refer instructions given on the bag.

NOTE

After using the warning triangle tie it firmly and keep it inside the bag to avoid rattling noise.

Hazard Warning Switch



Press the hazard warning switch to activate the hazard warning. All the turn signal lamps will flash simultaneously. To turn OFF, press the switch again.

Use the hazard warning to warn the traffic during emergency parking or when your vehicle could otherwise become a traffic hazard.

The hazard warning lamps can operate even if the ignition is switched off.

SPARE WHEEL REMOVAL PROCESS

- To access the spare wheel, open the tail gate and remove the cover provided on the spare wheel.



- To remove the spare wheel, unscrew and remove the retaining bolt.



EMERGENCY AND BREAKDOWN ASSISTANCE

IN CASE OF FLAT TYRE

- Reduce vehicle speed gradually, Avoid sudden steering movement or braking.
- Pay attention to the traffic conditions as you do so.
- Switch on the hazard warning lamps.
- Stop the vehicle on solid, non-slippery and level ground, as far away as possible from traffic.
- If possible, bring the front wheels into the straight-ahead position.
- Secure the vehicle against rolling away.
- Set the parking brake firmly.
- Switch off the motor.
- Keep advance warning triangle at a suitable distance behind the vehicle as an indication of breakdown.
- Close all the doors.

WARNING

If you drive with a flat tyre, there is a risk of the following hazards:

- A flat tyre affects the ability to steer or brake the vehicle.
- You could lose control of the vehicle.
- Continued driving with a flat tyre will permanently damage the tyre and cause excessive heat buildup and possibly a fire. There is a risk of an accident.

WARNING

DO NOT jump start the vehicle, since it is an EV. If the 12V battery is completely discharged, contact the nearest TATA MOTORS EV Service Centre.

Changing Flat Tyre

Loosen the nuts (as indicated) on the wheel in diagonal sequence. Do not unscrew the nuts completely before raising the vehicle using the jack.



Wheel nut removal

NOTE

- *The jack is designed only to raise and hold the vehicle for a short time while a wheel is being changed. It is not suited for performing maintenance work under the vehicle.*

EMERGENCY AND BREAKDOWN ASSISTANCE

- Use the jack on level, hard ground. Avoid changing the wheel on uphill and downhill slopes. Chock the wheels, if the deflated wheel needs to be changed on slope / ghat area.
- Before raising the vehicle, secure it from rolling away by applying the parking brake.
- Do not use wooden blocks or similar objects as a jack underlay.
- Do not place your hands and feet or lie under the raised vehicle when it is supported by a jack.
- The vehicle should be in power off condition, when the vehicle is supported by the jack and never allow passengers to remain in the vehicle.
- Do not open or close a door or the tailgate when the vehicle is raised.

Assemble the Jack handle and wheel spanner (as shown in fig.).

Position the jack vertically and raise it by turning the jack handle clockwise until the jack sits completely on the specified point

and the base of the jack lies evenly on the ground.

The jack up points are indicated by cutouts on the front and rear.

Jack Up Point Location on Vehicle

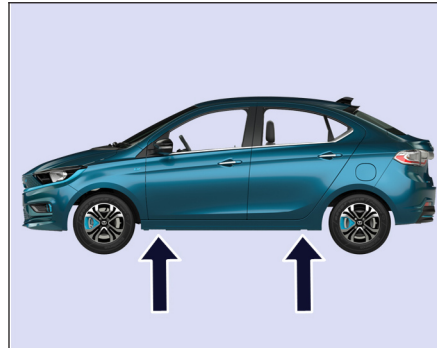

Jack up point location

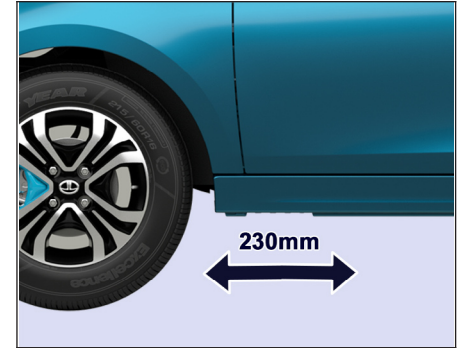

Front jacking location

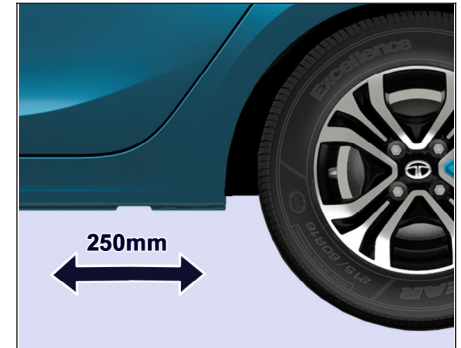

Rear jacking location

EMERGENCY AND BREAKDOWN ASSISTANCE

WARNING

If you do not position the jack correctly at the appropriate jacking point of the vehicle, the jack could tip over with the vehicle raised. There is a risk of injury. Also jack can be damaged.

Use wheel spanner to loosen the wheel nuts and then jack the vehicle.

Continue to raise the jack slowly and smoothly until the tyre clears the ground. Do not raise the vehicle more than required.



Lifting the rear wheel using jack

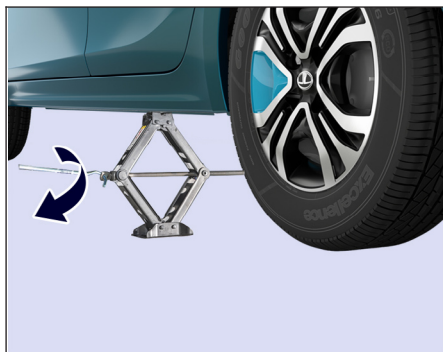

Lifting the front wheel using jack

Remove wheel nuts with the help of wheel spanner and take out flat tyre.

NOTE

Do not place wheel nuts in sand or on a dirty surface. Do not apply oil or grease on it.

Roll the spare wheel into position and align the holes in the wheel studs.

Tighten each nut by hand until the wheel is securely seated on the hub.

Lower the jack completely then tighten the wheel nuts one by one using wheel spanner.

Press fit the wheel cover back (if fitted).

Restore all the tools and jack at their respective locations.

Place the flat tyre at spare wheel location.

NOTE

- *Do a check and correct the tyre pressure and wheel nuts tightness of the changed wheel at nearest authorized service station. Get the flat tyre repaired at the earliest.*
- *Place the jack only at recommended jacking locations.*

TIRE PUNCTURE REPAIR KIT (if equipped)

WARNING

Compliance to below instructions is vital to ensure vehicle safety and personal safety. Non-compliance may result in serious injury or death. Damage to tire will affect vehicle handling and lead to loss of overall vehicle control.

Instructions

- The tire puncture repair kit seals most tire punctures to restore temporary mobility.
- Recommended use only for passenger car ground tubeless tires only and vehicle tire inflation pressure up to 300kPa (3 bar /43psi).
- The system consists of a compressor and a sealant, and serves to effectively and conveniently seal punctures in car tires caused, for example, by nails or similar foreign objects with a diameter of up to 1/4" (6 mm).
- Depending on the type and extent of

tire damage, some tires can only be partially sealed or not sealed at all.

- Loss of tire pressure can affect vehicle handling and vehicle control.
- Drive with caution and avoid making sudden steering or driving maneuvers, especially if the vehicle is heavily loaded or you are towing a trailer.
- The system will provide you with an emergency temporary repair, enabling you to continue your journey to the next vehicle or tire dealer, or to drive a maximum distance of 200 Kms.
- Do not exceed a maximum speed of 80 km/h.
- Keep the Puncture repair Kit out of the reach of children.
- If used for other than its intended purpose, the tire puncture repair Kit may cause severe accident or injury due to the fact that compressed air can act as an explosive or propellant.
- Park your vehicle at the roadside so that you do not obstruct the flow of traffic and you are able to use the Punc-

ture repair Kit without being in danger.

- Engage the hand brake, even if you have parked on a level road, to ensure that the vehicle will not move.
- Do not attempt to remove foreign objects like nails or screws penetrating the tire leave them as it is.
- Always ensure the vehicle engine is running during the tire puncture repair kit is in use, but not if the vehicle is in an enclosed or poorly ventilated area.
- Never leave the tire puncture repair kit unattended while in use.
- Do not keep the compressor operating for more than 10 minutes otherwise there is a risk of it overheating.
- Replace the sealant bottle with a new one before the expiry date is reached (see bottle label). In case that the sealant is expired the functionality cannot be fully guaranteed. Only use original tire puncture repair kit bottles which are pressure resistant.

EMERGENCY AND BREAKDOWN ASSISTANCE

WARNING

Do not use the Puncture repair Kit if the tire has already been damaged as a result of being driven underinflated. Do not try to seal damage other than that located within the visible tread of the tire. Do not try to seal damage to the tire's sidewall.

WARNING

TPMS/iTPMS (if equipped) functionality to be checked by authorized TATA MOTORS service center, if any error occurs due to the use of tire puncture repair kit.

Tire Puncture Repair Kit Location

To access the puncture repair kit open the Tailgate.

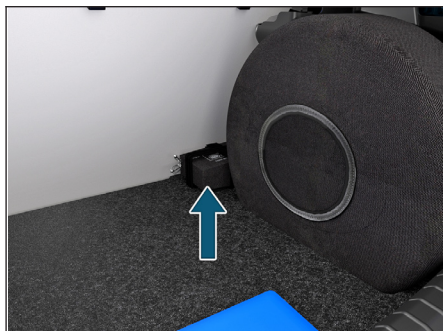

In Luggage Compartment

Tire Puncture Repair Kit Removal Process



Remove the two Velcro as shown in figure and take out the puncture repair kit.

Steps:

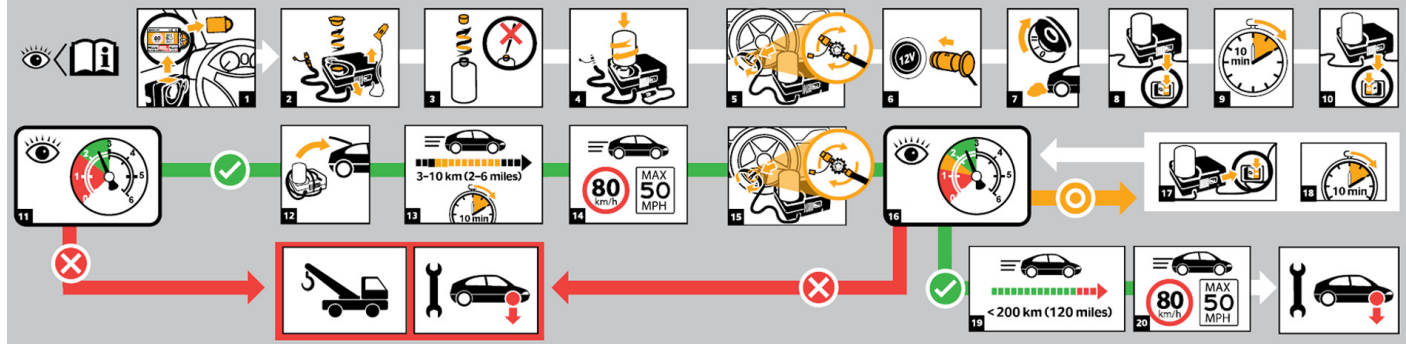

How To Proceed In The Event Of A Tire Puncture In Two Steps

First pump the tire sealant and air into the tire (see Step 1). Immediately there-after, drive a short distance (3-10 km) in order to distribute the sealant in the tire. After that check the tire pressure and pump more air into the tire if necessary (see Step 2). Then you can proceed to drive with caution for a maximum distance of 200 kms and at a maximum speed of 80 km/h. First pump the tire sealant and air into the tire

(see Step 1). Immediately there-after, drive a short distance (3-10 km) in order to distribute the sealant in the tire. After that check the tire pressure and pump more air into the tire if necessary (see Step 2). Then you can proceed to drive with caution for a maximum distance of 200 kms and at a maximum speed of 80 km/h.

Step 1: Pumping The Tire Sealant And Air Into The Tire

1. Take the hose and power plug with cable out of the tire puncture repair kit

casing. Unscrew the orange cap of the bottle connector.

2. Unscrew the red cap of the sealant bottle. (Shake sealant bottle well before use.)
3. Leave the bottle seal intact. Screwing the bottle onto the bottle holder will pierce the seal of the bottle. Avoid skin contact with the sealant which contains natural rubber latex. Do not open pressure "air release" valve.
4. Remove the valve cap from the dam-

EMERGENCY AND BREAKDOWN ASSISTANCE

aged tire. Pull the protective cap off the end of the hose and screw the hose firmly onto the valve of the damaged tire. Make sure that the compressor switch is switched to "0" and the pressure "air release" valve is closed.

5. Insert power plug into the 12 volt power socket connection.
6. Start the vehicle in idling (only if the vehicle is outdoors or in a well ventilated area).
7. Press compressor switch to "I".
8. Inflate the tire to an inflation pressure of minimum 180kPa, (1.8 bar/26 psi) and a maximum of 300kPa (3 bar/43 psi).

WARNING

Ensure pump should not be ON for more than 10 min as it may heat up and stop working.

WARNING

Check the sidewall of the tire prior to inflation. If there are any cracks, bumps

or similar damage, do not attempt to inflate the tire. Do not stand directly beside the tire while the compressor is pumping. Watch the sidewall of the tire. If any cracks, bumps or similar damage appear, turn off the compressor and let the air out by means of the pressure "air release" valve. In this case, do not continue to use the tire.

NOTE

When pumping in the sealant through the tire valve, the pressure may rise up to 500 kPa (5 bar/73 psi) but will drop again after about 30 seconds.

WARNING

Need to drain fluid from tire before repair.

Step 2: Checking The Tire Pressure

1. Once a tire inflation pressure of at least 180kPa (1.8 bar/26 psi) has been reached. Switch the compressor to "0" in order to read the actual tire pressure

from the pressure gauge.

2. Pull the power plug from the 12 volt power socket connection.
3. Slowly unscrew the hose from the tire valve (sealant residues may escape from the hose) and put the protective cap back onto the hose.
4. Leave the bottle in the holder. This avoids unexpected leakage of sealant residue.
5. Make sure the Puncture repair Kit, the cap of the bottle and the orange cap are stored safely, but are still easily accessible, in the vehicle.
6. The kit will be needed again when you check the tire pressure.
7. Start and drive for about 3-10 km so that the sealant can seal the damaged area. Do not drive for more than 10 min and not faster than 80 km/h.
8. Stop the vehicle after driving about 3-10 km. Check and where necessary, adjust the pressure of the damaged tire. Remove the protective cap from the end of the hose. Screw the hose

EMERGENCY AND BREAKDOWN ASSISTANCE

- firmly onto the valve of the damaged tire. Read the tire pressure from the pressure gauge.
- If the pressure of the sealant-filled tire is 130kPa (1.3 bar/19 psi) or more, it must now be adjusted to the pressure specified for your vehicle (Refer Tire pressure sticker pasted on driver door side).
 - Deflate the tire to the specified pressure using the pressure “air release” valve. Rest of the remaining sealant in the hose might leak out when opening pressure “air re-lease” valve or taking off the protective cap of the hose. Please use protective glove for safety purpose.
 - Once you have inflated the tire to its correct tire pressure, switch off the compressor, pull the plug out of the socket, unscrew the hose, fasten the tire valve cap and put back on the protective cap of the hose.
 - Leave the bottle in the holder and store the Puncture repair Kit away safely in the vehicle trunk
 - Drive to the nearest workshop to get the damaged tire repaired and if the tire repair is not possible it should be removed from the car. Before the tire is removed from the rim, inform your tire dealer that the tire contains sealant.

WARNING

If heavy vibrations, unsteady steering behavior or noises should occur while driving, reduce your speed and drive with caution to a place where it is safe for you to stop the vehicle. Recheck the tire and its pressure. If the tire pressure is less than 130kPa (1.3bar, 19 psi) or if there are any visible cracks, bumps or similar damage on the side wall, do not continue to use the tire!

WARNING

If heavy vibrations, unsteady steering behavior or noises should occur while driving, reduce your speed and drive with caution to a place where it is safe for you to stop the vehicle. Recheck the

tire and its pressure. If the tire pressure is less than 130kPa (1.3bar, 19 psi) or if there are any visible cracks, bumps or similar damage on the side wall, do not continue to use the tire!

For Normal Tire - Checking / Inflation of Tire Pressure Follow the Below Process

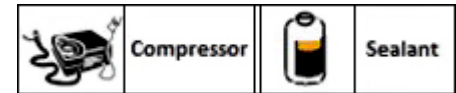

- Remove the puncture repair kit from the luggage area.
- Insert the power plug into the 12V power socket connection and start the vehicle in idling.
- Remove the plug from the tire valve and screw the inflator hose into the tire valve
- Press the switch to “I” present on the inflator and the motor will start to inflate.
- As specified pressure is achieved then

EMERGENCY AND BREAKDOWN ASSISTANCE

switch to “0” present on the inflator and compressor will turn off.

- Check the tire pressure again. If tire pressure is too high, deflate the tire to the specified pressure using the pressure “air release” valve.
- Remove the inflator hose from the tire valve and plug the tire valve safely.
- Remove the power plug 12V from the power socket and assemble it properly and keep the unit in luggage space again for next use.

NOTE

Remember that emergency road-side tire repair kits only provide temporary mobility. You should consult a tire specialist for advice.

NOTE

New sealant and replacement parts can be purchased from your authorized repair shop or dealer. Sealant bottles can be disposed with household waste

TOWING

When towing a break down vehicle, certain precautions and procedures must be taken to prevent damage to the vehicle and/or components. Failure to follow standard towing procedures could result in an accident or injury due to the unsafe operating condition.

To ensure proper towing and to prevent accidental damage to your vehicle, take help of a TATA MOTORS Authorized EV Service Centre or a commercial tow-truck service.

NOTE

Make sure that the parking brake is released; vehicle in neutral position and steering wheel is unlocked. The power steering functions only when motor is running. Hence, during towing the steering efforts will be more.

Recommended Towing

In case of break down, we recommend that your vehicle be towed with the driving wheels off the ground or place the vehicle on a flatbed truck as shown.

WARNING

- Do not tow your vehicle with the front wheels on the ground or four wheels on the ground (for-ward or backward), as this may cause serious damage to the E-Drive.
- When towing with the rear wheels on the ground or on towing dollies, place the ignition switch in the ‘ACC’ or ‘ON’ position, and secure the steering wheel in the straight-ahead position.

Wrong method:

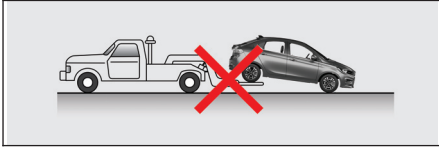

Correct methods:

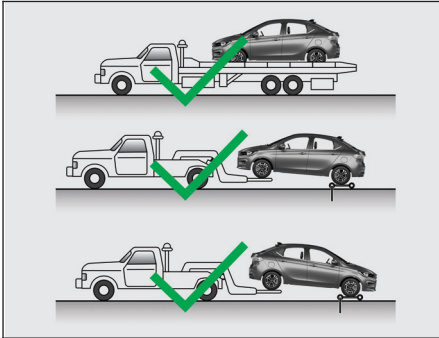

Emergency Towing

If towing is necessary, we recommend you contact the nearest TATA MOTORS authorised EV dealer or EV service centre.

To avoid serious damage to your EV, do not flat tow it. In an emergency situation, use extreme caution when towing the vehicle with a cable or chain. A driver must be in the vehicle to steer and operate the brakes. Towing, in this case, should be done only on hard surfaced roads for a short distance at low speeds (max 20 kmph).

In case of mechanised or flat bed towing is not available, your vehicle can be temporarily towed using a Cable, Chain, Tow rope or rigid tow bar connected to the emergency towing hook at the front of the vehicle



WARNING

- Do not get under your vehicle after it has been lifted by a tow truck.
- For towing a vehicle, the best way is to use a flat bed truck. Alternatively use a rigid tow bar or cable as emergency.
- Switch 'ON' the hazard warning indicators of both the vehicles to warn other road users.
- Limit the speed to 20 kmph.
- In case of brake failure, use the parking brake to control the vehicle.
- Fasten the tow rope or tow bar at the towing eyes. Otherwise, the vehicle could be damaged.
- When towing, pull away slowly and smoothly. If the tractive power is too high, the vehicles could be damaged.

EMERGENCY AND BREAKDOWN ASSISTANCE

Tow Hook Fitment

- Open the tailgate and remove tow hook from the tool kit.
- Open the tow hook cover provided on the front bumper by pressing it at the bottom part and simultaneously pulling it at the top (as shown in fig). Screw in and tighten the tow hook in clockwise direction.
- After towing, remove the towing hook and press fit the cover properly.
- Place the towing hook in the vehicle tool kit.



FUSES

Your vehicle has Low Voltage fuse boxes at three locations.

The vehicles electrical circuits have fuses to protect the wiring from short circuits or sustained overload.



1. Battery Mounted LV fuse box
2. Motor Compartment LV fuse box
3. Cabin compartment LV fuse box

Checking and Replacing Fuses

If any electrical unit in your vehicle is not functioning, examine the fuses.

Please follow the steps below that will guide you to check and replace them.

- Apply parking brake
- Switch off all the electrical gadgets.
- Turn the ignition key to the 'LOCK' position and remove the key out.
- In the fuse box, identify the defective fuse from its melted wire.

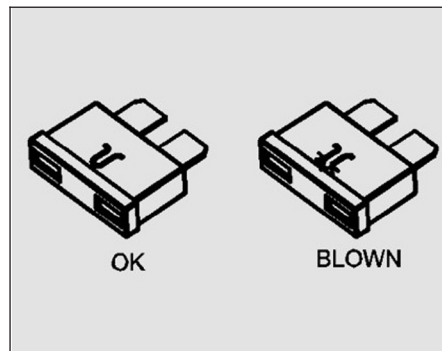

- Remove the blown fuse by “fuse

puller". The fuse puller and spare fuses are available in the motor compartment fuse box.

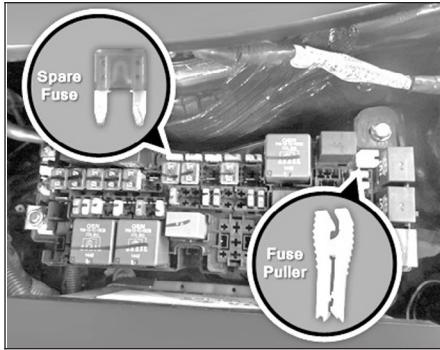

Motor compartment fuse box

i NOTE

Make sure that the spare fuses are added.

- Make sure that all other fuses are pressed firmly in position.
- If a newly installed fuse also blows, have the cause traced and rectified at nearest TATA MOTORS Authorized EV

Service Centre immediately.

⚠ WARNING

If you manipulate or bridge a defective fuse or if you replace it with a fuse with higher amperage, the electric cables could be overloaded and causes fire. There is a risk of an accident and injury. Always replace defective fuses with the specified new fuses having the correct amperage.

Battery Mounted LV Fuse Box

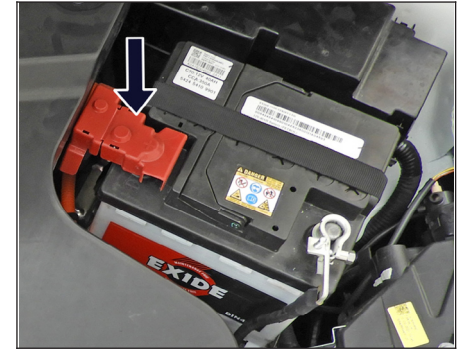

Fuse No.	Function	Fuse Rating
F01	DC-DC converter	200 A

i NOTE

The battery mounted fuse is not replaceable. If F01 fuse blows, the 12V battery +ve cable along with fuse has to be replaced.

EMERGENCY AND BREAKDOWN ASSISTANCE

Motor Compartment Fuse Box

The motor compartment fuse box is located under the bonnet on the left hand side of the vehicle behind the 12V battery.

- Blown fuses must be replaced with fuses of same rating, which you can recognize by color and value.

NOTE

Always ensure that the spare fuses are replenished.

- Ensure that all other fuses are pressed firmly in position.

If a newly inserted fuse also blows, have the cause traced and rectified at nearest TATA MOTORS Authorized EV Service Centre immediately.

Accident disconnect fuse

In case of an accident, to disconnect the high voltage battery from the rest of the high voltage electrical components, remove the cover of the fuse and pull out the accident disconnect fuse. The fuse can be identified with a yellow label.

WARNING

In case of Accident/Emergency/Crash, the rescuer or first emergency responder may be prone to Electric Hazard.

To avoid the Electric hazard, the Power supply to Battery Management System must be disconnected.

Follow the steps below to disconnect the power supply from the battery management system:

- Open the fuse box cover located under the bonnet behind the 12V battery without touching any other High Voltage Components.



- Remove the Accident Disconnect 10A fuse. The fuse puller and spare fuses are provided in the motor compartment fuse box.
- The 10A fuse labelled in yellow color as shown in image.

EMERGENCY AND BREAKDOWN ASSISTANCE

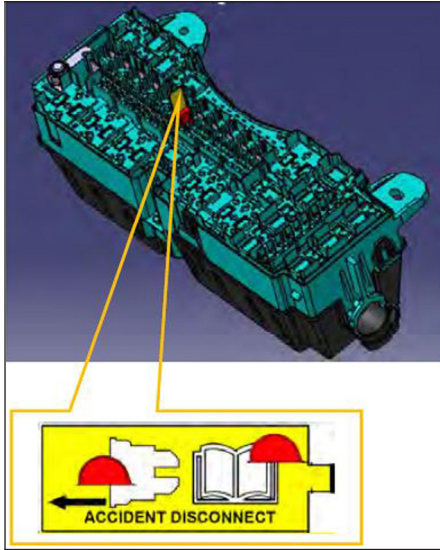

NOTE

The fuse box layout is for reference purpose only. Please refer the sticker provided inside the fuse box cover.

WARNING

If Fuse box cover is removed for any reason, it should be refitted properly at its original position.

EMERGENCY AND BREAKDOWN ASSISTANCE

Under The Bonnet Fuse Box

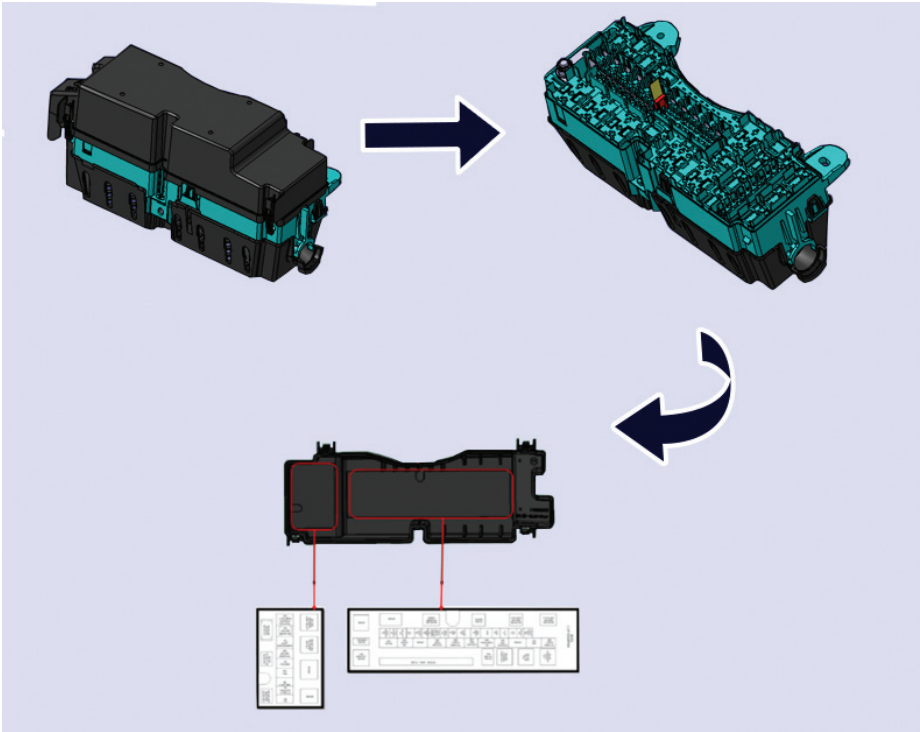

EMERGENCY AND BREAKDOWN ASSISTANCE

Under Bonnet Fuse Box – Layout and details

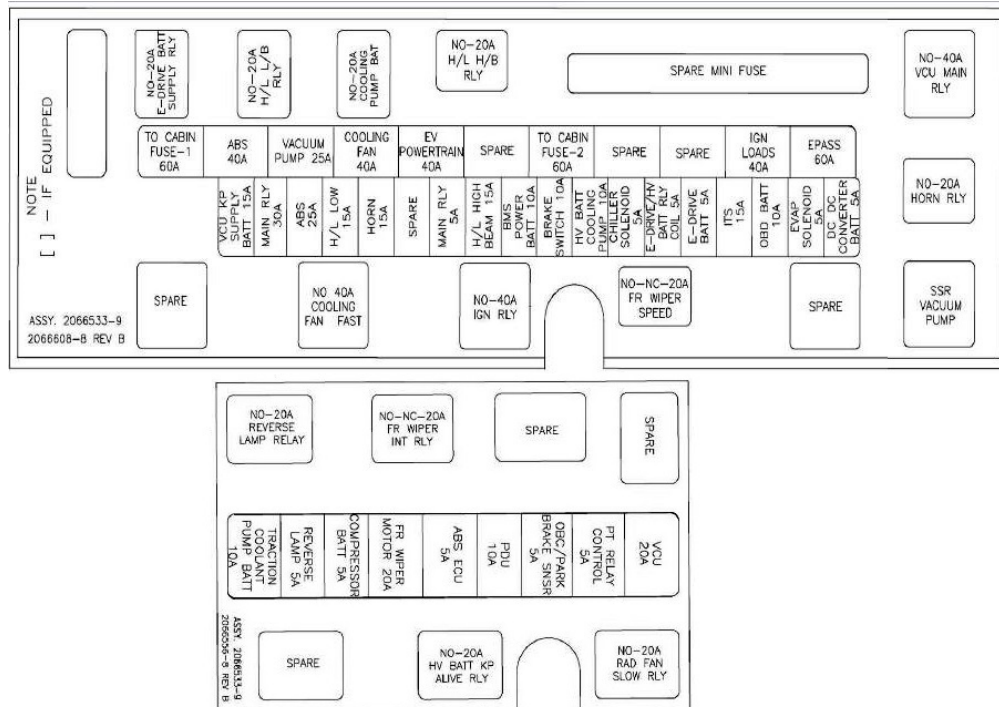

EMERGENCY AND BREAKDOWN ASSISTANCE

Fuse No.	Value	Type	Description
EF1	60A	SLOW BLOW	INTERIOR F/B 1 IGNITION
EF2	40A	SLOW BLOW	ABS
EF3	25A	SLOW BLOW	VACUUM PUMP
EF4	40A	SLOW BLOW	COOLING FAN
EF5	40A	SLOW BLOW	EV POWERTRAIN
EF6	-	SLOW BLOW	SPARE
EF7	60A	SLOW BLOW	INTERIOR F/B 2 BATTERY
EF8	-	SLOW BLOW	SPARE
EF9	-	SLOW BLOW	SPARE
EF10	40A	SLOW BLOW	IGNITION LOAD
EF11	60A	SLOW BLOW	EPAS
EF12	15A	FAST BLOW	VECU BATT.
EF13	30A	FAST BLOW	VECU MAIN RELAY
EF14	25A	FAST BLOW	ABS ECU
EF15	15A	FAST BLOW	HEAD LAMP LOW BEAM
EF16	15A	FAST BLOW	HORN HIGH/LOW TONE
EF17	-	FAST BLOW	SPARE
EF18	5A	FAST BLOW	VECU MAIN RELAY BATT
EF19	15A	FAST BLOW	HEAD LAMP HIGH BEAM
EF20	10A	FAST BLOW	BMS BATT.
EF21	10A	FAST BLOW	BRAKE LAMP

EMERGENCY AND BREAKDOWN ASSISTANCE

Fuse No.	Value	Type	Description
EF22	10A	FAST BLOW	HV BATT. COOLANT PUMP
EF23	5A	FAST BLOW	CHILLER SOLENIOD
EF24	5A	FAST BLOW	E-DRIVE/HV BATT. RELAY COILS
EF25	5A	FAST BLOW	E DRIVE BATT
EF26	15A	FAST BLOW	ITS
EF27	10A	FAST BLOW	HV OBD BATT.
EF28	5A	FAST BLOW	EVAPORATOR SOLENIOD
EF29	5A	FAST BLOW	DC-DC CONVERTER
EF38	20A	FAST BLOW	VECU BATT.
EF39	5A	FAST BLOW	EV POWERTRAIN RELAY CONTROL
EF40	5A	FAST BLOW	OBC/CCS ACTUATOR
EF41	10A	FAST BLOW	PDU BATT.
EF42	5A	FAST BLOW	ABS ECU
EF43	20A	FAST BLOW	FRONT WIPER MOTOR
EF44	5A	FAST BLOW	EV AC COMPRESSOR
EF45	5A	FAST BLOW	REVERSE LAMP
EF46	10A	FAST BLOW	TRACTION COOLANT PUMP

EMERGENCY AND BREAKDOWN ASSISTANCE

Under Bonnet Relay Details

Fuse No.	Value	Type	Description
R1	25A	SSR	VACUUM PUMP RELAY
R2	-	MICRO	-
R3	20A	MICRO NO	HV BATT KP ALIVE RELAY
R4	40A	MINI NO	VECU - MAIN RELAY
R5	-	MICRO	-
R6	40A	MINI NO	COOLING FAN CONTROLLER
R7	20A	MICRO NO - NC	INT WIPER ON
R8	20A	MICRO NO	COOLANT PUMP RELAY
R9	-	MINI	-
R10	-	MINI	-
R11	-	MICRO	-
R12	20A	MICRO NO	EV BATT. E DRIVE RELAY
R13	20A	MICRO NO	HEAD LAMP LOW BEAM
R14	20A	MICRO NO	

Fuse No.	Value	Type	Description
			HEAD LAMP HIGH BEAM
R15	-	-	-
R16	20A	MICRO NO	HORN
R17	40A	MINI	IGNITION
R18	20A	MICRO NO - NC	FRONT WIPER SPEED
R19	20A	MICRO NO	REVERSE LAMP RELAY

EMERGENCY AND BREAKDOWN ASSISTANCE

Under Bonnet Low Voltage Service Disconnect

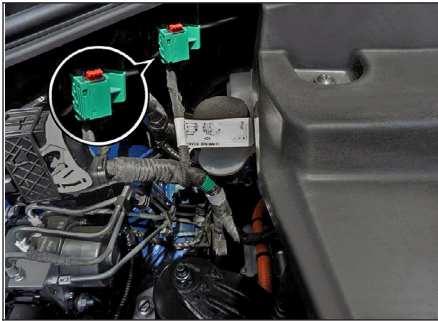

Isolation of high voltage components through low voltage Service Disconnect in case of emergencies.

A low voltage Service Disconnect connector is provided under the bonnet of the vehicle. If it is disconnected, the low voltage Service Disconnect the High Voltage Interlock circuits.

- A low voltage Service Disconnect connector is located on water channel, above brake booster.
- It is labeled with yellow color flag as

per below image.

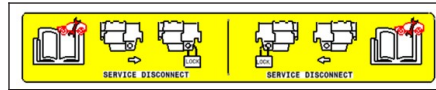

Without touching any other high voltage components, Disengage the Low voltage “Service Disconnect”, in case of emergencies. Remove lock before disconnecting.

Process For Low Voltage Service Disconnect

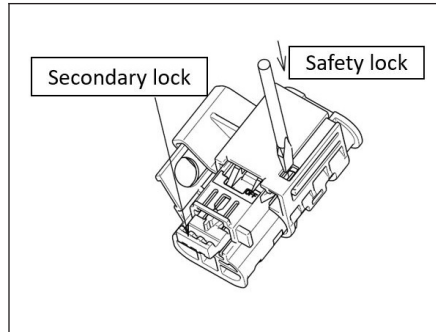

- Secondary lock need to be opened and then safety lock to be pulled with suitable tool.

- After successfully completion of service, press the secondary lock inside and safety lock to its original position.

WARNING

- During any kind of servicing of the vehicle, the Technician/Service operator can be prone to Electric Hazard.
- To avoid such electric hazard, the high voltage system should be disconnected by removing the MSD before service the vehicle.

NOTE

Disengage service disconnect & use lock while servicing / emergency for safe work on vehicle. To start vehicle again remove lock and engage service disconnect.

EMERGENCY AND BREAKDOWN ASSISTANCE

Cabin Compartment LV Fuse Box

Cabin Removal Procedure

Fuse box is located in the cover below steering column. To access the fuse box, remove cover as per procedure given below.

1. Fuse box cover is mounted on dash board with the help of lugs at the top and bottom of the cover from inside.



2. To remove the cover, gently pull the cover from bottom side such that the lugs get disengaged.

Re-fitment Procedure

Align and engage the top and bottom

mounting lugs with respective slots on dash board and press the cover firmly.

Fuses

Cabin compartment fuse box

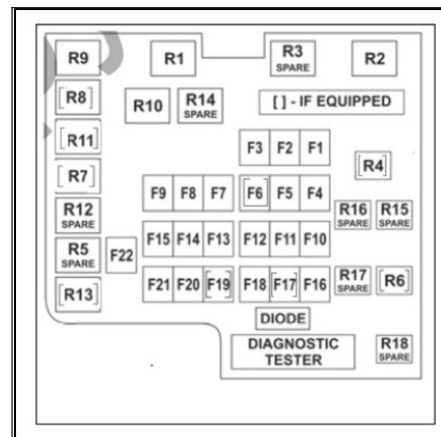

Cabin compartment fuse box layout

EMERGENCY AND BREAKDOWN ASSISTANCE

Fuses - Cabin Compartment Fuse Box Details

Fuse No.	Fuse Rating	Type	Description
F1	10A	FAST BLOW	RESTRAINT CONTROL MODULE
F2	15A	FAST BLOW	ACC CONN. & OBD
F3	5A	FAST BLOW	TELEMATICS
F4	20A	FAST BLOW	BODY CONTROL MODULE
F5	5A	FAST BLOW	PRNDS/CHARGER GUN LOCK-UNLOCK
F6	5A	FAST BLOW	MIRROR ADJUST MOTORS (XZ+)
F7	20A	FAST BLOW	BODY CONTROL MODULE
F8	5A	FAST BLOW	INSTRUMENT CLUSTER
F9	20A	FAST BLOW	BODY CONTROL MODULE (XZ+)
F10	5A	FAST BLOW	KEY-IN (XE+ &XM) / PEPS ACC. RELAY FEEDBACK (XZ+)
F11	5A	FAST BLOW	EPAS/PEPS IGN
F12	5A/15A	FAST BLOW	ACCESSORIES (XE+ & XM)/POWER SOCKET REAR(XZ+)
F13	30A	FAST BLOW	BLOWER MOTOR

Fuse No.	Fuse Rating	Type	Description
F14	15A	FAST BLOW	CDL
F15	5A	FAST BLOW	PDC/TELEMATICS IGN
F16	5A/10A	FAST BLOW	KEY IN(XE+ & XM) / PEPS (XZ+)
F17	10A	FAST BLOW	T/G LATCH (XZ+)
F18	10A	FAST BLOW	HVAC/FATC
F19	25A	FAST BLOW	HEATED REAR WINDOW (XZ+)
F20	10A	FAST BLOW	MODULE KL.15 I/P IGNITION
F21	15A	FAST BLOW	POWER SOCKET FRONT
F22	15A	FAST BLOW	TRANSIT/INFOTAINMENT

EMERGENCY AND BREAKDOWN ASSISTANCE

Cabin Compartment Fuse Box Relay Details

Relay No.	Rating (a)	Relay Type	Description
R1	40A	MINI NO	ACC, RELAY
R2	40A	MINI NO	BLOWER RELAY
R3	-	MINI	-
R4	-	BUZZER	BUZZER
R5	-	MICRO	-
R6	20A	MICRO NO	HEATED REAR WINDOW (XZ+)
R7	20A	MICRO NO-NC	CDL LOCK MICRO (XM & XZ+)
R8	20A	MICRO NO-NC	CDL UNLOCK MICRO (XM & XZ+)
R9	-	MICRO	-
R10	20A	MICRO NO	IGNITION RELAY
R11	20A	MICRO NO	T/G LATCH RELAY (XZ+)
R12	-	MICRO	-
R13	20A	MICRO NO	WW SIGNAL INVERSION RLY MICRO (XZ+)
R14	-	MICRO	-
R15	-	MICRO	-
R16	-	MICRO	-

Relay No.	Rating (a)	Relay Type	Description
R17	-	MICRO	-
R18	-	MICRO	-

EMERGENCY AND BREAKDOWN ASSISTANCE

24 X 7 ROAD ASSISTANCE

Dear Customer,

It is our responsibility and our endeavour to ensure that you have our complete service backup if ever, wherever and whenever you need the same. When you have a road network that spans wide area, the probability of a breakdown happening within hailing distance of a TATA MOTORS Authorized EV Workshop is very low.

It is precisely for this reason, we have tied up with TVS AA, who will provide breakdown assistance including towing to the nearest TATA MOTORS Authorized EV Workshop through their Authorized EV Service Providers (ASP).

The 24X7 On Road Assistance Program shall be automatically available to your vehicle for the duration of Warranty period. The program shall also be available, if you avail the same post warranty.

Response Time ** for the On Road Assistance Program

Within City Limits	60 minutes
On State or National Highways	90 minutes
Ghat Roads and other places	120 minutes +/-
States of North-East, J&K and HP	Same Day (Within 24 Hrs)

** (The response time will depend on the location, terrain, traffic density and the time of the day)

Standard procedure when calling for on Road Assistance in case of a breakdown:

- Dial the toll free help line number – ☐ 1800 209 8282
- Identify your vehicle with the Vehicle chassis number that is available in the Owner's Manual.
- Explain your exact location with landmarks and tell us about the problem you face with the vehicle.
- Park your vehicle on the edge of the

road, open the bonnet and put on the hazard warning signal.

- Place the advance warning triangle supplied with the vehicle approx. 3 m from the vehicle in the direction of on-coming traffic.



Coverage Under 24 X 7 On Road Assistance Program

1. The 24x7 On Road Assistance Program Service covers the following services on your vehicle during warranty period.
 - Wheel change through spare wheel.
 - Mobile charging facility is free for 4

EMERGENCY AND BREAKDOWN ASSISTANCE

times within warranty and charge upto 5 KWH can only be provided and available in select cities presently Delhi, Mumbai, Bengaluru, Pune and Hyderabad. If the service is expanded to other cities, customers will be duly informed.

- Re-opening the vehicle in cases of key lock out.
- Rectification of electrical problems related to battery, fuses etc.
- On spot repairs for complaints repairable at site. ^
- Vehicle to vehicle towing or winching & towing for non-accident cases up to the nearest TATA MOTORS Authorized EV Dealer/Service Centre. Towing charges at actual cost beyond the same to be paid to the ASP in cash. (Any ferry or toll charges levied in relation to the vehicle being towed to be paid by the customers in actuals in cash).
- For accident cases, towing charges to be borne by the customer.

2. The **24x7 On Road Assistance** Program coverage on availing the 24X7 policy, post warranty is upto maximum of 6 instances of assistance in one year for both the plans- Basic and Premium. In the premium plan, this includes 2 instances of towing up to the nearest TATA MOTORS Authorized EV Dealer/Service Centre.

Exclusions

24 X 7 On Road Assistance Program does not apply to

- Cost of parts consumables and labour for such repairs not covered under warranty*. These charges are to be settled with ASP in cash.
- Toll or ferry charges paid by ASP in reaching to the breakdown site to be settled with ASP at actuals in cash.
- Cases involving accident, fire, theft, vandalism, riots, lightening, earthquake, windstorm, hail, tsunami, unusual weather conditions, other acts of God, flood, etc.
- Vehicles that are unattended, unregistered, impounded or abandoned.
- Breakdown/defects caused by misuse, abuse, negligence, alterations or modifications made to the vehicle.
- Lack of maintenance as per the maintenance schedule as detailed in the owner's manual.
- Cases involving racing, rallies, vehicle testing or practice for such events.

EMERGENCY AND BREAKDOWN ASSISTANCE

Disclaimer

- The Service is not available in Lakshadweep.
- **The reach time is indicative & the actual reach time will be conveyed by the call center at the time of breakdown call.
- The reach time can vary depending on the traffic density & time of the day.
- The reach time indicated does not account for delays due to but not limited to acts of God, laws, rules & regulations for time being in force, orders of statutory or Govt. authorities, industrial disputes, inclement weather, heavy down pour, floods, storms, natural calamities, road blocks due to accidents, general strife and law & order conditions viz. fire, arson, riots, strikes, terrorist attacks, war etc.
- ^On spot repairs at breakdown site shall depend on nature of complaints & will be as per the discretion of the ASP.
- * The decision for free of charge re-

pairs will be as per the warranty policy & procedures of TATA PASSENGER ELECTRIC MOBILITY LTD. and as per the interpretation of the same by ASP. You will be duly in-formed by the ASP & call center for the change applicable if any.

- All charges wherever applicable need to be settled directly with the ASP.

Exclusion of Liabilities

- It is understood that TATA MOTORS shall be under no liability whatsoever in respect of any loss or damage arising directly or indirectly out of any delay in or non-delivery of, defect/deficiency in service/parts provided by ASP.
- In case vehicle cannot be repaired on-site, customers are advised to use the towing facility for taking their vehicle to the nearest TATA MOTORS authorized EV workshop only. In no condition shall the vehicle be towed to any unautho-rized workshop. TATA MOTORS will not be responsible for any repairs car-ried out in such unauthorized work-shop.

- Customer are advised to take acknowledgment from the ASP for the list of accessories/extra fittings and other belongings in the vehicle as well as the current condition related to dents/scratches breakages of parts/fitments of the vehicle at the time of ASP taking possession of the vehicle & to verify these items when delivery is taken back by them, Claim for loss of or damage to items, if any should be taken up with ASP directly. TATA MOTORS shall not be responsible for any such claims, damages/loss or any de-ficiency of service of the ASP.
- Vehicles will be handled, repaired & towed as per the customer's risk & TATA MOTORS shall not be liable for any damages / claims as a result of the same.
- Services entitled to the customers can be refused or canceled on account of abusive behavior, fraudulent representation, malicious intent and refusal to pay the charges for any charges related services and spare parts during service or on previous occasions on

EMERGENCY AND BREAKDOWN ASSISTANCE

part of the customer.

- On site repairs may be temporary in nature. The completion of repairs does not certify the road worthiness of the vehicle. The customer is advised to ensure temporary repairs carried out on-site is followed by permanent repairs at a TATA MOTORS Authorized EV Dealer/Service Center at the earliest. Terms and conditions and service coverage, exclusions etc are subject to change without notice.

In case of Emergency

If the EV stalls at a crossroad or crossing

If the vehicle stalls at a crossroad or crossing, rotate the rotary knob to N (Neutral) position and then push the vehicle to a safe place.

If the vehicle stalls while driving

- Reduce your speed gradually, keeping a straight line. Move cautiously off the road to a safe place.
- Turn on the hazard lamps.
- Try to start the vehicle again. If your vehicle will not start, contact an authorized TATA MOTORS EV dealer or seek other qualified assistance.
- Since this vehicle runs on electric power, it generates little sound. Be aware of your driving environment and drive safely.
- After you park the vehicle or while you are waiting at a traffic light check whether there are kids or obstacles around the vehicle.

- Check if there is something behind the vehicle when driving in reverse. Pedestrians may not hear the sound of the vehicle.

If an accident occurs...

- If your vehicle is drivable, park your vehicle off the road; rotate the gear selector knob to “N” and apply the parking brake.
- If not drivable do not try to start the vehicle. Rotate the gear selector knob to N and apply the parking brake.
- Roll down the windows and open the door locks if possible. If the ‘Ready’ message does not come in the instrument cluster, do not try to switch ON the supply by pressing the Start/Stop button.
- If there is no electrical supply, at least try to unlock single door manually.
- If the vehicle ‘Ready’ message flashes in the instrument cluster, press the Start/Stop button to turn off the supply, and ensure ‘Ready’ message goes off to verify the high-voltage system is disconnected.

EMERGENCY AND BREAKDOWN ASSISTANCE

- De-latch the bonnet from inside the cabin by pulling the lever to open it.
- If the lever is not reachable, do not spend time to de-latch the bonnet.
- Come out of the vehicle and move the smart key at least 2 meters away from the vehicle to avoid any accidental restart or activation of high voltage systems.
- Try to evacuate the occupants from inside of the vehicle.
- Secure vehicle by barricading it, without touching the vehicle.
- Inform the TATA MOTORS On-Road-Assistance immediately.
- Do not touch the vehicle. Keep a safe distance.

WARNING

- Do not touch electric wires that may become exposed from inside or outside the vehicle, high voltage electric wires (orange), connectors and any exposed electric components and devices. Doing so may result in

electric shock and lead to injuries or even death.

- If you observe any coolant leaks and rupture in refrigerant lines, do not drive the vehicle and contact TATA MOTORS On-Road Assistance.
- If the vehicle switches off after an accident, come out of the vehicle immediately without touching any metal parts.
- Leaks or damage to the High voltage battery may result in a fire. If you discover them, contact emergency services immediately. Never touch the fluid leaked inside or outside the vehicle. If the fluid contacts with your skin or eyes, wash it off immediately with a large amount of water or saline solution and seek immediate medical attention to avoid serious injury.
- If your vehicle is flooded or if water has soaked the carpets, you should not try to start the vehicle. Never touch the high voltage cables, con

nectors and package modules, because an electric shock may occur causing injury or death. (High voltage components are orange in colour).

- Do not touch your vehicle, if the vehicle has been submerged in water. The high voltage battery may cause shock or may catch fire. Immediately contact the authorities and advise them of the condition of your vehicle and that an electric vehicle is involved.

If a small scale fire occurs, use a fire extinguisher (C, ABC, BC) that is meant for electrical fires. If it is impossible to extinguish the fire in the early stage, remain at a safe distance from the vehicle and immediately call the authorities. Also, advise them that an electric vehicle is involved.

When approaching a high voltage vehicle in a situation of fire, rescue or recovery, follow the standard rule:

- Always assume the high-voltage system is live in the vehicle.

EMERGENCY AND BREAKDOWN ASSISTANCE

- Only High Voltage System trained personnel with necessary high voltage PPEs (hand gloves, electrical safety shoes, etc.,) should access and analyse the EV after all occupants are safely evacuated.

Emergency Shut Off System

When vehicle detects any fault in HV system, it activates the emergency shut off for safety purpose. Even if the gear knob is in Drive mode, the system may shutoff suddenly. In this case, contact the nearest TATA MOTORS authorized EV dealer to rectify the issue.

MAINTENANCE and SERVICES

Periodic maintenance is essential for ensuring long trouble free performance.

Have your vehicle serviced regularly from TATA MOTORS Authorized EV Service Centre.

There is a large network of TATA MOTORS Authorized EV Service Centre to help you with their professional servicing expertise. Scheduled maintenance information is provided which makes tracking routine service easy.

The following checks can be carried out between the recommended scheduled maintenance services. Take help of our authorized service centre for assistance.

- Brake fluid level
- Traction cooling/Battery cooling system level
- Washer fluid level checking & topping up
- LV Battery electrolyte
- Tyre inflation pressure including spare wheel.

NOTE

Refer “Opening and Closing” section for front bonnet opening.

WARNING

- Keep all open flames and other burning material (such as cigarettes) away from the Vehicle.

MAINTENANCE AND SERVICES

DO IT YOURSELF

- Check the coolant level in the coolant reservoir and brake fluid level once in month.
- Check for operations of all exterior lights, including the stop light, turn signals and hazard warning flashers once in month.
- Always check the inflation pressures of all tires including the spare is as per specification.
- Check the windshield washer spray and wiper operation. Clean the wiper blades with clean cloth dampened with washer fluid.
- Check of the headlight alignment.
- Check for worn tires and loose wheel nuts.
- Check for air conditioning flow, if not adequate take your vehicle to nearest service station.
- Clean the battery and terminals
- Ensure the radiator and FMS are dust free to prevent particle buildup and clogging

- Keep an eye on the motor temperature (shown on instrument cluster). If you notice the temperature raising more than it usually does, that probably means that your vehicle's radiator isn't performing at top efficiency and needs radiator parts maintenance.
- Always keep your vehicle clean and dust free.

NOTE

Since the electrical components of Tigor.ev are not user serviceable, it is recommended that you approach your nearest TATA MOTORS authorized EV Service Centre to replace any electrical components of the car

Instruction For Cleaning the Charging Port

- Keep the charge lid always closed.
- When the lid is open ensure that dust caps are in closed position.
- Ensure that drain outlet is not blocked.
- During Slow charging make sure that DC dust cap in in closed position.

- In case of dust/mud/snow accumulation in charging port, it can be cleaned by blowing air into the charging port. Never use any water or liquid for cleaning purpose.

NOTE

Water entering into the charging port will always be drained through the drain system.

MOTOR COMPARTMENT

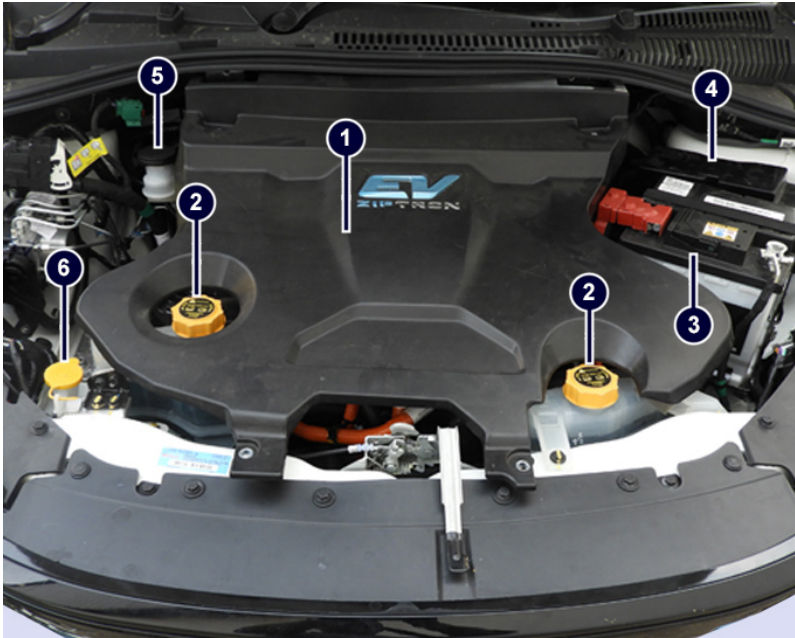

1. High voltage components
2. Coolant tank
3. Low voltage battery
4. Motor compartment fuse box
5. Brake fluid reservoir
6. Windshield Washer reservoir

MAINTENANCE AND SERVICES

Brake Fluid Level

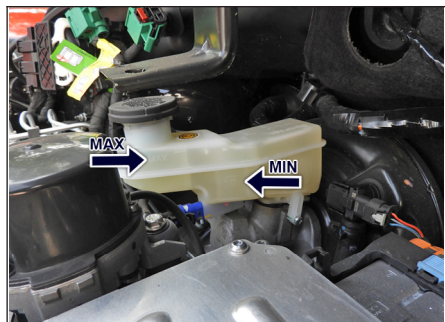

The level of the brake fluid should be between the 'MIN' and 'MAX' marks on the side of the brake fluid container. If the level falls below the 'MIN' mark, add recommended brake fluid.

i NOTE

*Do not allow brake fluid to make contact with the skin or eyes.
Do not allow brake fluid to splash or spill on the paint surface, as it will damage the paint. In case of spillage, wipe it off immediately.*

Windshield Washer Fluid Level



Fill the washer fluid in the tank if the washer fluid level is low.

i NOTE

- *Do not use detergent or any other additive in the windshield washer reservoir. This can severely impair visibility when sprayed on the windshield, and can damage your vehicle's paint.*
- *Do not operate washer motor with no fluid in washer tank, washer*

motor will be damaged

Auxiliary Battery (12V)

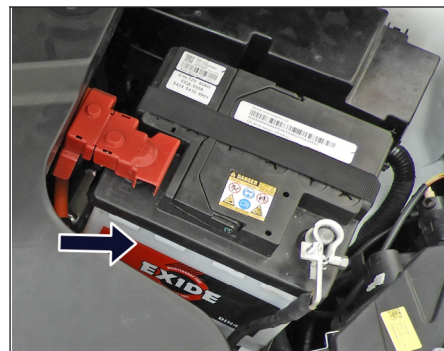

- Check the battery for electrolyte level against the marking on the battery outer case.
- Check the battery terminals for corrosion, clean it with dry cloth.
- Coat the terminals with petroleum jelly to prevent further corrosion.
- Use a proper wrench to loosen and remove cables from the terminals.

- Always disconnect the negative (-ve) terminal first and reconnect it last.
- If you need to connect the battery to a charger, disconnect both cables to prevent damage to the vehicle's electrical system.

NOTE

- *During normal operation, the battery generates gas, which is explosive in nature. A spark or open flame can cause the battery to explode causing very serious injuries.*
- *Keep all sparks, open flames and smoking materials away from the battery.*
- *The battery contains sulphuric acid (electrolyte) which is poisonous and highly corrosive in nature. Getting electrolyte in your eyes or on the skin can cause severe burns. Use protective clothing and a face shield or have a skilled technician to do the battery maintenance.*

Reduction Gear Fluid

To check or add reduction gear fluid, it is recommended that you visit TATA MOTORSS Authorized EV Service centre for the same.

CAUTION

- Use only ATF recommended by TATA MOTORS. Do not mix with other fluids.
- The Using reduction gear fluid other than recommended ATF will cause deterioration in drivability and reduction gear durability, and may damage the reduction gear, which is not covered by the warranty.

MAINTENANCE AND SERVICES

High-pressure Washing

High pressure washing is not allowed in the motor bay and on the battery connectors.

- When using high-pressure washers, make sure to maintain sufficient distance from the vehicle. Insufficient clearance or excessive pressure can lead to component damage or water penetration.
- Do not spray the camera, sensors or its surrounding area directly with a high pressure washer. Shock from high pressure water may cause the device to not operate normally.
- Do not bring the nozzle tip close to boots (rubber or plastic covers) or connectors as they may be damaged if they come into contact with high pressure water.

TYRES

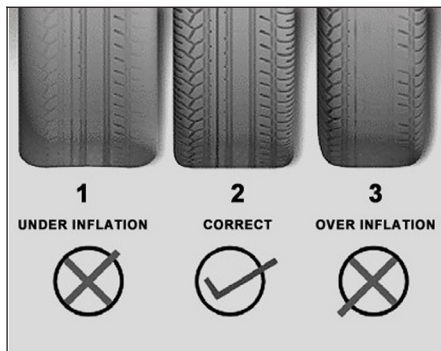

1	Under Inflation	Too much side tread wear
2	Correct tyre pressure	Uniform wear
3	Over Inflation	Too much center tread wear

Inflation

Do a check for inflation and condition of your vehicle tyres periodically.

Examine the pressure in the tyres when they are cold.

Keep the correct pressure in the tyres for the best combination of riding comfort, handling, tyre life and optimum performance.

Over inflation of tyres makes the vehicle ride bumpy and harsh. Tyres are more prone to uneven wear and damage from road hazards.

Under inflated tyres reduce comfort, affects handling and increases the operating temperature, which can result in failure. They also cause uneven wear and bring down the performance of the car.

i NOTE

Every time you check inflation pressure, you should also examine tyres for damage, trapping of foreign objects in the treads and wear.

Recommended Tyre Pressures

Tyre Size	Wheel	Tyre Pressure
175/65 R14 86T	Front	33 psi(2.3 bar)
	Rear	38 psi (2.6 bar)
	Spare	38 psi (2.6 bar)

Tyre Pressure Sticker Location

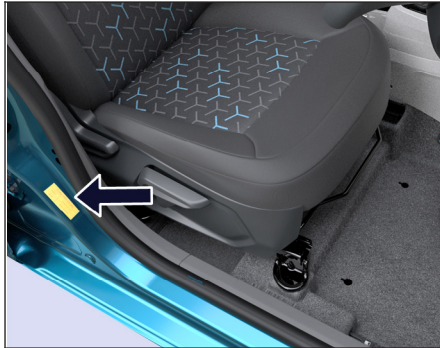

i NOTE

- Keep the tyre pressures as specified on tyre pressure sticker.

Special Care for Tubeless Tyres

- When you remove the tyre and install it back on the rim take precautions not to damage tyre bead. Use tyre removal and assembly machines. Damage or cut on tyre bead may cause gradual loss of air and deflation of tyre.
- Do not scratch inner surface of tubeless tyre with metallic or sharp object. Tubeless tyres are coated with impermeable layer of rubber from inner surface which holds the air in the tyre. Removal of this layer due to scratching may cause gradual loss of air and deflation.
- If wheel rim gets damaged in service, get the wheel rim repaired/ replaced immediately. Running the vehicle with damaged rim may cause deflation of tyre and subsequent dislodging of tyre from rim.
- Keep the recommended inflation pressure. Over-inflation, in particular, may cause puncture or bursting of tyre.

i NOTE

Life and wear pattern of tyres depends on various parameters like tyre pressure, wheel alignment, wheel balancing, tyre rotation, etc. It also largely depends on vehicle speed, load carried, usage, driving habits, road conditions, tyre quality, etc. In case fault is suspected to be due to poor quality of tyres, the same may be taken up with concerned tyre manufacturer.

MAINTENANCE AND SERVICES

Tyre Rotation

To help increase tyre life and distribute wear more evenly you should have tyres rotated at specified intervals or earlier depending on the operation of vehicle.

The illustrations show how to rotate tyres when normal or temporary spare wheel is fitted.

For 175/65 R14 tyres

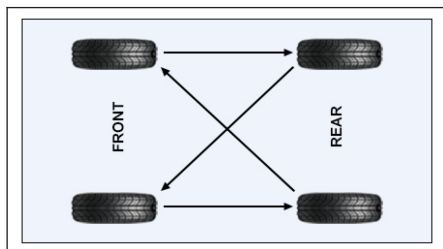

Wheel Balancing

Wheels of your vehicle are balanced for better ride comfort and longer tyre life. Balancing needs to be done whenever tyre is removed from rim.

WARNING

If the vehicle vibrates abnormally on a smooth road, get the wheel balancing done immediately.

Wheel Covers (if equipped)



Put a piece of cloth between the spokes of the wheel cover and pull it outwards. Take out detached wheel cover from the wheel rim.

When you install the cover, make sure that it does not block the air inlet valve. Apply equal pressure at the circumference of the wheel cover to fix it in the wheel rim.

NOTE

Do not use any sharp tools (such as screw driver etc.) to remove the wheel

MAINTENANCE AND SERVICES

REMOTE KEY BATTERY REPLACEMENT

Remote control key contains a battery which is housed under the cover.

If red LED remote flashes for 5 times after placing and releasing any button on remote. It is recommended to replace battery at a TATA MOTORS Authorized EV Service Centre.

You should, however, proceed as follows if you wish to replace the discharged battery yourself:

1. Open the key blade.
2. Press off the battery cover with your thumb or using a flat screw driver at the points of the arrows.
3. Remove the discharged battery from the key by pressing the battery downwards at the point of the arrow.



4. Insert the new battery.

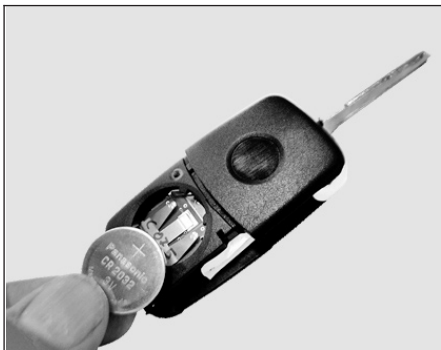

5. Ensure that the “+” symbol on the battery is facing upwards. The correct polarity is shown on the battery cover.
6. Position the battery cover on the key and press on it until it is heard to lock in place.

NOTE

An inappropriately disposed battery can be harmful to the environment and human health. Dispose the battery according to your local law(s) and regulation.

SERVICE INSTRUCTIONS

The **TATA Tigor.ev** has been manufactured to give you economical and trouble free performance. To achieve this, please follow the instructions as stated.

Your vehicle is entitled to three free services (labour only). The free service coupons are attached in this manual. Please present these coupons to the EV servicing dealer while availing free services.

1st free service - At 1,000-2,000km. OR 2 months, whichever is earlier.

2nd free service - At 7,000-8,000km. OR 6 months, whichever is earlier.

3rd free service - At 14,500-15,500km. OR 12 months, whichever is earlier.

All services other than free services are chargeable.

Servicing of the vehicle can be done at any TATA MOTORS Au-thorised EV Dealer Workshop or TATA MOTORS Authorised EV Service Centre (TASC).

Warranty claims can be settled by any TATA MOTORS Authorised EV Dealer Workshop or TATA MOTORS Authorised EV Service Centre (TASC).

MAINTENANCE AND SERVICES

SERVICE SCHEDULE

Sn	Operation	Kms →	1500	7500	15000	22500	30000	37500	45000	52500	60000	67500	75000	82500	90000	97500	105000	112500	120000	127500	135000	142500	150000
		Months →	2	6	12	18	24	30	36	42	48	54	60	66	72	78	84	90	96	102	108	114	120
		Frequency In '000 Kms / Months																					
1	Wash the vehicle & Clean Radiator Fins	Every Service	•	•	•	•	•	•	•	•	•	•	•	•	•	•	•	•	•	•	•	•	•
2	Check & Top up Fluids (If required): Transaxle Oil, Coolant, Brake Fluid, LV Battery Electrolyte, Wind Screen washer fluid	Every Service	•	•	•	•	•	•	•	•	•	•	•	•	•	•	•	•	•	•	•	•	•
3	Check HV Battery box under the vehicle for cracks/leakages	Every Service	•	•	•	•	•	•	•	•	•	•	•	•	•	•	•	•	•	•	•	•	•
4	Check all the HV cables for looseness, cuts, wear & tear	Every Service	•	•	•	•	•	•	•	•	•	•	•	•	•	•	•	•	•	•	•	•	•
5	Inspect cooling systems (Battery cooling system (BCS) and Traction cooling system (TCS))	Every Service	•	•	•	•	•	•	•	•	•	•	•	•	•	•	•	•	•	•	•	•	•

MAINTENANCE AND SERVICES

Sn	Operation	Kms →	1500	7500	15000	22500	30000	37500	45000	52500	60000	67500	75000	82500	90000	97500	105000	112500	120000	127500	135000	142500	150000	
		Months →	2	6	12	18	24	30	36	42	48	54	60	66	72	78	84	90	96	102	108	114	120	
		Frequency In '000 Kms / Months																						
6	Change coolant (Battery cooling system (BCS) and Traction cooling system (TCS))	# 60K/48 M									•									•				
7	Check and Capture all DTC's Clear all faults and Erase the Codes	Every Service	•	•	•	•	•	•	•	•	•	•	•	•	•	•	•	•	•	•	•	•	•	•
8	Check condition of rubber bushes/parts in lower control arms, front and rear coil spring seats, front & rear bump stoppers, anti roll bar links, rear twist beam, rubber boots/dust cover/bellow in rack & pinion, steering and suspension ball joints, steering column. Replace if necessary. (First at 7.5K/6M then at every service).	7.5K / 6M		•	•	•	•	•	•	•	•	•	•	•	•	•	•	•	•	•	•	•	•	

MAINTENANCE AND SERVICES

Sn	Operation	Kms →	1500	7500	15000	22500	30000	37500	45000	52500	60000	67500	75000	82500	90000	97500	105000	112500	120000	127500	135000	142500	150000
		Months →	2	6	12	18	24	30	36	42	48	54	60	66	72	78	84	90	96	102	108	114	120
		Frequency In '000 Kms / Months																					
	For severe usage, above checks to be done at every 5,000 km or after every severe usage event.																						
9	Check All door latch & striker operations , Adjust and apply grease if required	15K/12 M			•		•		•		•		•		•		•		•		•		•
10	Check for all bolts & nuts (Tighten). For severe usage, above checks to be done at every 5,000 km or after every severe usage event	Every Service	•	•	•	•	•	•	•	•	•	•	•	•	•	•	•	•	•	•	•	•	•
11	Check for tightening torque of all bolts & nuts of cradle FEM frame & A mount stud nyloc nut , B and C mount fastners	Every Service	•	•	•	•	•	•	•	•	•	•	•	•	•	•	•	•	•	•	•	•	•

MAINTENANCE AND SERVICES

Sn	Operation	Kms →	1500	7500	15000	22500	30000	37500	45000	52500	60000	67500	75000	82500	90000	97500	105000	112500	120000	127500	135000	142500	150000
		Months →	2	6	12	18	24	30	36	42	48	54	60	66	72	78	84	90	96	102	108	114	120
		Frequency In '000 Kms / Months																					
	BRAKES																						
12	Check front brake pads & rear brake linings. Replace if necessary	15K / 12M			•		•		•		•		•		•		•		•		•		•
13	Replace brake fluid , Check brake system components for Leakages	# 45K / 36M							•						•						•		
14	Inspect and if necessary adjust handbrake setting	15K/12 M			•		•		•		•		•		•		•		•		•		•
	WHEELS & TYRES																						
15	Check & adjust wheel alignment (For severe usage, above checks to be done at every 5,000 km or after every severe usage event)	# 15K / 12M			•		•		•		•		•		•		•		•		•		•
16	Check for Tyre pressure, condition & rotate	# 7.5 K / 6M		•	•	•	•	•	•	•	•	•	•	•	•	•	•	•	•	•	•	•	•

MAINTENANCE AND SERVICES

Sn	Operation	Kms →	1500	7500	15000	22500	30000	37500	45000	52500	60000	67500	75000	82500	90000	97500	105000	112500	120000	127500	135000	142500	150000
		Months →	2	6	12	18	24	30	36	42	48	54	60	66	72	78	84	90	96	102	108	114	120
		Frequency In '000 Kms / Months																					
TRANSAXLE																							
17	Oil change interval (First at 7.5K / 6M)	# 30K/24 M		•			•				•				•				•				•
ELECTRICAL																							
18	Check specific gravity of battery electrolyte for 12V Aux. battery	7.5K / 6M		•	•	•	•	•	•	•	•	•	•	•	•	•	•	•	•	•	•	•	•
19	Check headlamp focusing	15k/12M			•		•		•		•		•		•		•		•		•		•
A.C. SYSTEM																							
20	Check Air-conditioning / HVAC System for satisfactory performance	Every Service	•	•	•	•	•	•	•	•	•	•	•	•	•	•	•	•	•	•	•	•	•
21	Wire mesh filter cleaning	7.5K/6M		•	•	•	•	•	•	•	•	•	•	•	•	•	•	•	•	•	•	•	•
GENERAL																							
22	Charging socket area should be properly cleaned	Every Service	•	•	•	•	•	•	•	•	•	•	•	•	•	•	•	•	•	•	•	•	•

MAINTENANCE AND SERVICES

Sn	Operation	Kms →	1500	7500	15000	22500	30000	37500	45000	52500	60000	67500	75000	82500	90000	97500	105000	112500	120000	127500	135000	142500	150000
		Months →	2	6	12	18	24	30	36	42	48	54	60	66	72	78	84	90	96	102	108	114	120
		Frequency In '000 Kms / Months																					
23	Check HV battery plug for mud/dust/external particle accumulation. Clean the same by blowing air (define air pressure)	Every Service	•	•	•	•	•	•	•	•	•	•	•	•	•	•	•	•	•	•	•	•	•

Kms or months whichever occurs earlier

Note: Additionally, Tyre pressure to be checked every 15 days.

MAINTENANCE AND SERVICES

VEHICLE PARKING FOR LONG DURATION

If the vehicle needs to be parked for long duration, following care to be taken:

1. Park the vehicle in covered, dry and well ventilated premises & ensure the engagement of parking brake lever.
2. Block the wheel.
3. Remove the 12 V battery negative terminal ensuring that Low voltage battery fully charged.
4. Clean and protect the painted parts using protective wax.
5. Clean and protect the shiny metal parts using commercially available special compounds.
6. Sprinkle talcum powder on the rubber windscreen wiper and lift them off the glass.
7. Slightly open the windows.
8. Cover the vehicle with a cloth or perforated plastic sheet. Do not use sheets of imperforated plastic as they do not allow moisture on the vehicle body to evaporate.
9. Inflate the tyres to 0.5 bar above the normal specified pressure and check it at regular intervals.
10. Check the HV battery charge every six weeks.
11. The HV battery undergoes discharge at a rate of approximately 2% over a period of 30 days in storage. Do not allow the vehicle to be discharged to 0% in storage. It is recommended that the vehicle must be charged greater than 50% before leaving the vehicle for long time storage. After this time period the vehicle must be charged to 100% using Slow Charging or AC charging before use. This will keep the battery to full charge while also keeping the auxiliary power systems ready to use.
12. Do not drain the coolant of motor cooling system.

LUBRICATION SPECIFICATION

Use following genuine fluids, coolants and lubricants recommended for optimum performance of your vehicle.

Item	Specification	Company	Brand	Quantity
Battery cooling system - Coolant (Pre-mixed) (Antifreeze agent + Soft water 40:60 ratio)	Class II/JIS K2234 TATA SS7700S1	Sunstar CCI	TATA MOTORS original coolants	6 Litres
		Anchemco		
		Castrol		
Traction cooling system - Coolant (Pre-mixed) (Antifreeze agent + Soft water 40:60 ratio)	Class II/JIS K2234 TATA SS7700S1	Sunstar CCI	TATA MOTORS original coolants	5.3+/-0.1 Litres
		Anchemco		
		Castrol		
Transaxle oil	GEAR OIL BOT 350 M3	Castrol	Syntrans FE 75W/Trans Manual Mulivehicle FE 75W	0.9 Litres
Brake fluid	SAE J 1703, DOT 4	PETRONAS	PETRONAS TATA MOTORS Genuine Brake Oil DOT 4S	As required
		Sunstar CCI	Golden Cruiser TATA Genuine Brake Fluid (DOT4)	
		Castrol	Optional - Castrol- Universal Brake Fluid DOT 4	
Compressor oil	Zerol Ester 68	Zerol,M/S Climate	Zerol,M/S Climate	150+/- 10ml
Refrigerant	R-134a	-	-	490 +/-20 gm

TECHNICAL INFORMATION

TECHNICAL SPECIFICATIONS

Parameter	
Motor	
Type	345 V, Permanent magnet, synchronous motor
Installation	Transverse Electric power train FWD
Max. Power	55 kW
Max. Torque	170 Nm
Transaxle	
Model	Single speed, Automatic
No. of gears	1-Forward, 1-Reverse
Steering	
Type	Electrical Power assist Steering, Rack & Pinion Gear, collapsible Steering Column
Brakes	
Brakes	Front (Disc); Rear (Drum)
Parking brake	Cable Operated Mechanical (Variable Lever Ratio)
Suspension	
Type	Independent
Shock absorber	Shock absorber
Wheels & tyre	
Tyres	175/65 R14 86T (Radial tubeless tyre)
Wheel rims	5.5J X 14" Steel wheel

TECHNICAL INFORMATION

Parameter	
	5.5J X 14" Hyper style Steel wheel
Cab / body	
Type	Semi-mono volume, 4 doors sedan, steel monocoque body
Electrical system	
HV Battery	Lithium-ion 75 Ah (26 kWh)
Drivetrain	345V
Auxiliary battery	12V, 47Ah
Main Chassis dimension (in mm)	
Wheel base	2450
Track front	1400
Track rear	1420
Overall length	3993
Overall height	1529 (Unladen)
Max. Width	1677
Ground clearance	142
Performance	
Max. Speed	120 kmph
Max. Recommended gradability	28%
Min. Turning Circle Dia	10 m
Minimum Turning Clearance circle Dia	10.4 m

TECHNICAL INFORMATION

Parameter	
Weight (in kg)	
Gross vehicle weight	1594 (XM)
	1590 (XE+)
	1610 (XZ+)
Kerb weight (Unladen)	1219 (XM)
	1215 (XE+)
	1235 (XZ+)

VEHICLE DIMENSIONS

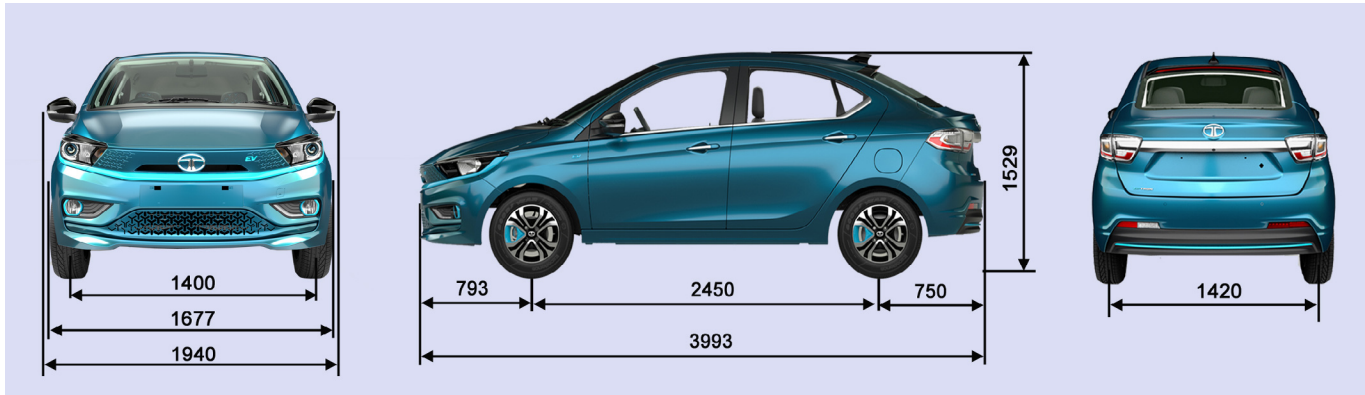

TECHNICAL INFORMATION

AGGREGATE IDENTIFICATION NUMBERS



Chassis number punching near driver seat



VIN plate near front passenger seat

CAR CARE

Your vehicle is subjected to many external influences such as climate, road conditions, industrial pollution and proximity to the sea. These conditions demand regular care of the vehicle body. Dirt, insects, bird droppings, oil, grease, fuel and stone chip-pings should be removed as soon as possible.

Washing

Following these tips while washing your vehicle.

1. Always wash your vehicle in shade and the surface is at room temperature.
2. Wash with mild vehicle wash soap like 'Car Shampoo' and use a soft bristle brush, sponge or soft cloth and rinse it frequently while washing to avoid scratches.
3. To avoid scratches, please wear soft gloves. Remove finger rings, nails, wrist watch while washing.
4. To remove stubborn stains and contaminants like tar, use turpentine or

cleaners like 'Stain remover' which are safe for paint surfaces.

5. Avoid substances like petrol, diesel, kerosene, benzene, thinner, acids or other solvents that cause damage to paint.
6. Dry your vehicle thoroughly to prevent any damp spots.
7. Rinse all surfaces thoroughly to prevent any traces of soap and other cleaners as this may lead to the formation of stains on the painted surface later.

NOTE

Avoid parking the car under trees without proper cover. This will reduce the amount of bird droppings, tree sap and pollen contact on the paint surface. Regularly remove the twigs, leaves and vegetation near the windshield areas to avoid water stagnation.

WARNING

Do not wash the vehicle with high pressure washer fluid/ water jets (Pressure above 0.5 bar) specifically at electrical devices under bonnet area and connector / underbody wiring harness during washing. This is to prevent malfunction / failure of electrical system due to water ingress.

After drying the vehicle, inspect it for chips and scratches that could allow corrosion to start. Apply touch up paint where necessary.

Cleaning of Carpets

Vacuum clean the carpet regularly to remove dirt. Dirt will make the carpet wear out faster. Periodically shampoo the carpet to keep it looking new.

Use carpet cleaners (preferably foam type). Follow the instructions that come with the cleaner. Apply it with a sponge or soft brush.

Keep the carpeting as dry as possible by not adding water to the foam.

CAR CARE

NOTE

Avoid wiping of painted surface in dry condition as it may leave scratches on the painted surface.

Cleaning of Windows, Front and Rear Glasses

Clean the windows inside and outside with commercially available glass cleaners.

This will remove the haze that builds up on the inside of windows. Use a soft cloth or paper towels to clean all glass and plastic surfaces.

Waxing

Waxing and polishing is recommended to maintain the gloss and wet-look appearance of your paint finish.

1. Use good quality polish and wax for your vehicle.
2. Re-wax your vehicle when the water does not slip off the surface but collects over the surface in patches.

Polishing

Polishes and cleaners can restore shine to the painted surface that has oxidized and become dull. They normally contain mild abrasives and solvents that remove the top layer of the finish coat. Polish your vehicle, if the finish does not regain its original shine after using wax.

Interior Fabric Cleaning Tips

1. Stains should be treated immediately. If left for a long time, they can leave a permanent mark.
2. Cleaning the stains immediately is important especially for stains which contain artificial colors in the stain creating liquid or semisolid substance. The colorant may leave a stain if kept for longer time.
3. Stain should not be removed by rubbing. As far as possible, try to blot or lift the stain with cloth or plastic spatula and then clean the remaining stain with cloth or sponge.

4. If the stain has dried, then gently brush off the material and then press with damp cloth or sponge till it disappears.
5. Do not use household detergents to clean the fabric.
6. Always use clean cotton cloth for cleaning.

Paint Care

Following guidelines will help you to protect your Vehicle from corrosion effectively. Avoid Spillage or direct contact of air freshener liquid/chemicals with painted plastic parts. These chemicals may cause damage to paint like blisters, peel off, wrinkles etc.

Proper Cleaning

In order to protect your vehicle from corrosion it is recommended that you wash your vehicle thoroughly and frequently in case:

- There is a heavy accumulation of dirt and mud especially on the underbody.
- It is driven in areas having high atmospheric pollution due to smoke, soot, dust, iron dust and other chemical pollutants.

- It is driven in coastal areas.
- Do not direct high pressure washer fluid/water jets (Pressure above 0.5 bar) at electrical devices and connector during washing. This is to prevent malfunction/failure of electrical system due to water ingress. No High pressure washing in under bonnet area, Under-floor battery pack and CCS Charging port.

In addition to regularly washing your car, the following precautions need to be taken.

Periodic Inspection

- Regularly inspect your vehicle for any damage in the paint film such as deep scratches and immediately get them repaired from an authorized service outlet, as these defects tend to accelerate corrosion.
- Inspect mud liners for damages.
- Keep all drain holes clear from clogging.

Proper Parking

- Always park your vehicle in shade to protect it from harsh sunlight or in a well-ventilated garage so that there is no dampness on any part of the vehicle.

Wiper Care

- To prevent damage to the wipers or windshield, do not operate the wipers when the windshield is dry.
- To prevent damage to the wiper arms and other components, do not attempt to move the wipers manually.

FASTAG

FAST TAG is pasted on front windshield from the inside. It enables Electronic toll collection.



NOTE

Do not attempt to rip or tamper the tag. It will disable the functionality of the tag.

CAR CARE

WARRANTY – TERMS AND CONDITIONS

We WARRANT each **TATA Tigor.ev** and parts thereof manufactured by us to be free from defect in material and workmanship subject to the following terms and conditions:

- 1. This warranty for Tigor.ev shall be for a period of 36 months from the date of sale or 1,25, 000 km, whichever occurs earlier. The warranty on the battery and motor shall be for a period of 96 months from the date of sale of car or a mileage of 1,60,000 KMs whichever occur earlier.**
2. Our obligation under this warranty shall be limited to repairing or replacing, free of charge, such parts of the car which, in our opinion, are defective, on the car being brought to us or to our dealers within the period. The parts so repaired or replaced shall also be warranted for quality and workmanship but such warranty shall be co-terminus with this original warranty.
3. Any part which is found to be defective and is replaced by us under the warranty shall be our property.
4. As for such parts as Tyres, 12 volt Batteries, Audio and / or Video equipment (if any), etc. not manufactured by us but supplied by other parties, this warranty shall not apply, but buyers of the car shall be entitled to, so far as permissible by law, all such rights as we may have against such parties under their warranties in respect of such parts.
5. This warranty shall not apply if the car or any part thereof is repaired or altered otherwise than in accordance with our standard repair procedure or by any person other than from our sales or service establishments, our authorized dealers, service centers or service points in any way so as, in our judgment which shall be final and binding, to affect its reliability, nor shall it apply if, in our opinion which shall be final and binding, the car is subjected to misuse, negligence, improper or inadequate maintenance or accident or loading in excess of such carrying capacity as certified by us, or such services as prescribed in our Owner's Manual are not carried out by the buyer through our sales or service establishments, our authorized dealers, service centres or service points.
- 6. This warranty shall not apply to the replacement of normal wear parts, including without limitation, hoses, wiper blades, fuses, brake shoes, brake pads, cables and all rubber parts (except oil seal and glass run).**
7. This warranty shall not cover any inherent normal deterioration of the car or any of its parts arising from the actual use of the car or any damage due to negligent or improper operation or storage of the car.
8. This warranty shall not apply to normal maintenance services like oils & fluid changes, head lamps focusing, fastener retightening, wheel balancing and alignment, tyre rotation, and consumables like bulbs, filters and AC gas leaks.

-
9. This warranty shall not apply to any damage or deterioration caused by environmental pollution or bird droppings. Slight irregularities not recognized as affecting the function or quality of the vehicle or parts, such as slight noise or vibration, defects appearing only under particular or irregular operations are items considered characteristics of the vehicle.
10. This warranty shall be null and void if the car is subjected to abnormal use such as rallying, racing or participation in any other competitive sport. This warranty shall not apply to any repair or replacements as a result of accident or collision.
11. This warranty is expressly in lieu of all warranties, whether by law or otherwise, expressed or implied, and all other obligations or liabilities on our part and we neither assume, nor authorize any person to assume on our behalf, any other liability arising from the sale of the car or any agreement in relation thereto.
12. The buyer shall have no other rights except those set out above and have, in particular, no right to repudiate the sale, or any agreement or to claim any reduction in the purchase price of the car, or to demand any damages or compensation for losses, incidental or indirect, or inconvenience or consequential damages, loss of car, or loss of time, or otherwise, incurred or accrued.
13. Any claim arising from this warranty shall be recognized only if it is notified in writing to us or to our authorized dealer without any delay soon after such defects as covered & ascertained under this warranty.
- 14. This warranty is fully transferable to subsequent vehicle owner. Only unexpired remaining period of warranty applies.**
15. We reserve our rights to make any change or modification in design of the car or its parts or to introduce any improvement therein or to incorporate in the car any additional part or accessories at any time without incurring any obligation to incorporate the same in the cars previously sold.

CAR CARE

EXTENDED WARRANTY

TATA MOTORS recommends the purchase of its extended warranty program.

Coverage - Mechanical + Electrical

Benefits

- Insures you against unforeseen break down repair bills.
- Documentation is simple and hassle free.
- Near cashless & speedy claim.

Term

36 + 12 months or 1,25,000 km whichever occurs first

OR

36 + 24 months or 1,50,000 km whichever occurs first

Extended Warranty is available in the dealership from where you have purchased your vehicle. We strongly recommend purchase of Extended Warranty at time of purchase of your vehicle. Extended Warranty can be availed till 548 days from date of purchase of vehicle. The Dealer Service Marketing Executive shall explain to you the Terms and conditions, Coverage and Owner's responsibility.



Note

- The extended warranty comes into force once the manufacturer's warranty expires e.g. after 36 Months.
- It is more restrictive as by the time it comes into force the vehicle is already 36 months old.

What is Covered?

- Mechanical / Electrical break down as defined in this warranty and confirmed by the dealer within the stipulated terms and conditions.
- TATA MOTORS EV dealer shall either repair or replace any part found to be defective with a new part or an equivalent at no cost to the owner for parts or labour.
- Such defective parts which have been replaced will become property of TATA PASSENGER ELECTRIC MOBILITY LTD.

What is not covered?

Please refer the Extended Warranty Booklet for details of the exclusion list.

Owner's Responsibility:

- Proper use, maintenance and care of the vehicle in accordance with the instructions contained in the Owner's Manual and Service Booklet. The records of the same to be ensured in Owner's Manual.
- Retention of maintenance service bills.

I / We have been explained the Terms and conditions, Coverage and Owner's responsibility by the Dealer Service Marketing Executive.

I wish to avail / Do not wish to avail extended warrant policy.

Customer's Signature**Dealer's Signature**

CAR CARE

VALUE ADDED SERVICES

Why are Corrosion Protection Waxes necessary?

Corrosion is Caused by:

Water / salt water acid rain & atmospheric fallouts.

Critical Areas are:

Cavities: joints, crevices, spot welds, underbody

- Corrosion is the most important factor when we talk about the vehicle life. If you treat your car well, you can prolong the life.
- It is very dangerous to drive around in a corroded vehicle.
- The corrosion creeps onto the vehicle from the inside and from the outside. The most dangerous kind of corrosion is often not discovered until it is too late.

Benefits of Anti - Rust Treatment:

- A professionally applied range of world class products offering real value to the new and used vehicle customer.
- The treatment has been developed to withstand the harshest environmental and climatic conditions (rust. Pollutants, stone and gravel impact, etc.)
- Insulate cabin space from external noises.
- Expensive tin work, denting and painting can be avoided.
- Higher resale value for the vehicle.
- Higher safety – uncorroded vehicle
- 10 free checkups available



TATA MOTORS has tied up with **M/s Wurth, M/s Autokrom, M/s 3M India Lt d & M/s Bardahl** for these world class treatment at affordable prices. These treatments are available in all authorized workshops. The Dealer Service Marketing Executive will explain to you the benefits and terms and conditions of this treatment.

I / We have been explained the Benefits, Terms and conditions and the prices of these treatments by the Dealer Service Marketing Executive.

I wish to avail / Do not wish to avail extended warrant policy.

Customer's Signature

Dealer's Signature

CAR CARE

VEHICLE EXTERIOR ENRICHMENT

Why Vehicles are Painted?

- For Corrosion protection of the metal surfaces.
- Ease of application from other corrosion protection treatments.
- Cheaper than other corrosion protection methods eg. Galvanizing, anodizing.
- For decoration and identification.

Various Environmental Hazards Affecting Paints

Environmental hazards: damage your vehicle's finish.

Even as your new vehicle rolls off the assembly line, the paint is not protected.

The Enemy

Ultraviolet Rays, Pollution, Tree Sap, Bird Droppings, Car Wash Chemicals, Road Salt, Acid Rain.

Benefits: Vehicle Exterior Enrichment

- Removal of medium scratches, orange peel, oxidation, dust nibs etc. & swirl marks from painted surface.
- Restoration of original gloss levels, UV protection after gloss is restored.
- Cleaning & dressing of tyres, Bumpers and all exterior plastic moldings/trims.

TATA MOTORS has tied up with **M/s Autokrom**, **M/s 3M** & **M/s Wurth** for this world class treatment at affordable prices.

This treatment is available in all authorized workshops. The Dealer Service Marketing Executive will explain to you the benefits and terms and conditions of this treatment.



VEHICLE INTERIOR ENRICHMENT

Why protect your new car's fabric interior?

- Someone will soil your vehicle's fabric carpet or seats.
- A significant detractor from your vehicle's resale value.
- A permanent stain on your vehicle's interior fabric.

The Enemy:

Drink spills, Food stains, mud, Ultraviolet rays, Pets, and Traffic

Benefits: Vehicle Interior Enrichment

- Removal of medium stains and dirt from all interior parts of the car i.e., carpet, upholstery and roof lining.
- Cleaning of windshield and all windows (inside and outside).
- Dressing of all internal plastics (eg: door pad trims) and rubber parts.
- The treatment involves cleaning and dressing of all parts of the exposed interiors.
- Specialized protection for seat fabric from liquid spills.

TATA MOTORS has tied up with **M/s Wurth** and **M/s Autokrom** for this world class treatment at affordable prices. This treatment is available in all authorized workshops. The Dealer Service Marketing Executive will explain to you the benefits and terms and conditions of this treatment.

I / We have been explained the Terms and conditions, Coverage and Owner's responsibility by the Dealer Service Marketing Executive.

I wish to avail / Do not wish to avail extended warrant policy.

Customer's Signature

Dealer's Signature

ENVIRONMENTAL SAFETY

TATA MOTORS is committed to produce vehicles using environmentally sustainable technology. TATA MOTORS vehicles have been designed to ensure environmental compatibility throughout the life cycle of the vehicle. We would also like to inform you that your vehicle is a zero emission and environmental friendly vehicle.

Customer's copy



PDI Coupon
Tigor.ev

Pre Delivery Inspection

Owner's Name:

VIN No.:

Engine / Motor No.:

Reg. No.:

ODO Reading:

Date of Service:

Service Dealer's Stamp & Signature

Dealer's copy



PDI Coupon **Tigor.ev**

Pre Delivery Inspection

AVAIL ALL SERVICES TO GET BENEFIT OF WARRANTY

This Coupon entitles for free labour jobs.(Refer maintenance section)

Owner's Name:

VIN No.:

Engine / Motor No.:

Reg. No.:

Date of Sale:

Service Dealer code:

ODO Reading:

Date of Service:

I hereby certify that the PDI has been carried out to my entire satisfaction.

Customer's Signature

Service Dealer's Stamp & Signature

(Free Service coupons are valid at all TATA Authorized Service Centers in India)



Customer's copy

1st Free Service Coupon

Tigor.ev

Valid for 1000 - 2000 kms. OR 2 months,
Whichever is earlier

Owner's Name:

VIN No.:

Engine / Motor No.:

Reg. No.:

ODO Reading:

Date of Service:

Service Dealer's Stamp & Signature



Dealer's copy

TATA

1st Free Service Coupon

Tigor.ev

Valid for 1000 - 2000 kms. OR 2 months, whichever is earlier.

AVAIL ALL SERVICES TO GET BENEFIT OF WARRANTY

This Coupon entitles for free labour jobs.(Refer maintenance section)

Owner's Name:

VIN No.:

Engine / Motor No.:

Reg. No.:

ODO Reading:

Date of Sale:

Date of Service:

Service Dealer code:

I hereby certify that the service has been carried out to my entire satisfaction.

Customer's Signature

Service Dealer's Stamp & Signature

(Free Service coupons are valid at all TATA Authorized Service Centers in India)



Customer's copy

2nd Free Service Coupon

Tigor.ev

Valid for 7000 - 8000 kms. OR 6 months,
whichever is earlier

Owner's Name:

VIN No.:

Engine / Motor No.:

Reg. No.:

ODO Reading:

Date of Service:

Service Dealer's Stamp & Signature



Dealer's copy

TATA 2nd Free Service Coupon Tigor.ev

Valid for 7000 - 8000 kms. OR 6 months, whichever is earlier.

AVAIL ALL SERVICES TO GET BENEFIT OF WARRANTY

This Coupon entitles for free labour jobs.(Refer maintenance section)

Owner's Name:

VIN No.:

Engine / Motor No.:

Reg. No.:

ODO Reading:

Date of Sale:

Date of Service:

Service Dealer code:

I hereby certify that the service has been carried out to my entire satisfaction.

Customer's Signature

Service Dealer's Stamp & Signature

(Free Service coupons are valid at all TATA Authorized Service Centers in India)



Customer's copy

3rd Free Service Coupon

Tigor.ev

Valid for 14,500 – 15,500 kms. OR 12 months, whichever is earlier

Owner's Name:

VIN No.:

Engine / Motor No.:

Reg. No.:

ODO Reading:

Date of Service:

Service Dealer's Stamp & Signature



Dealer's copy

TATA

3rd Free Service Coupon

Tigor.ev

Valid for 14,500 – 15,500 kms. OR 12 months, whichever is earlier.

AVAIL ALL SERVICES TO GET BENEFIT OF WARRANTY

This Coupon entitles for free labour jobs.(Refer maintenance section)

Owner's Name:

VIN No.:

Engine / Motor No.:

Reg. No.:

ODO Reading:

Date of Sale:

Date of Service:

Service Dealer code:

I hereby certify that the service has been carried out to my entire satisfaction.

Customer's Signature

Service Dealer's Stamp & Signature

(Free Service coupons are valid at all TATA Authorized Service Centers in India)

Tigor.ev



TATA MOTORS | SERVICE
॥•u•oi•lvll° ''''••t• • ३३३
va•u•

Call us: 1800 209 8282 | Mail us: customercare@tatamotors.com | Visit us: service.tatamotors.com

5456 5840 9901

Developed by: Technical Literature Cell ERC.



545658409901